

THE MULTIGUARD

Protection Solution

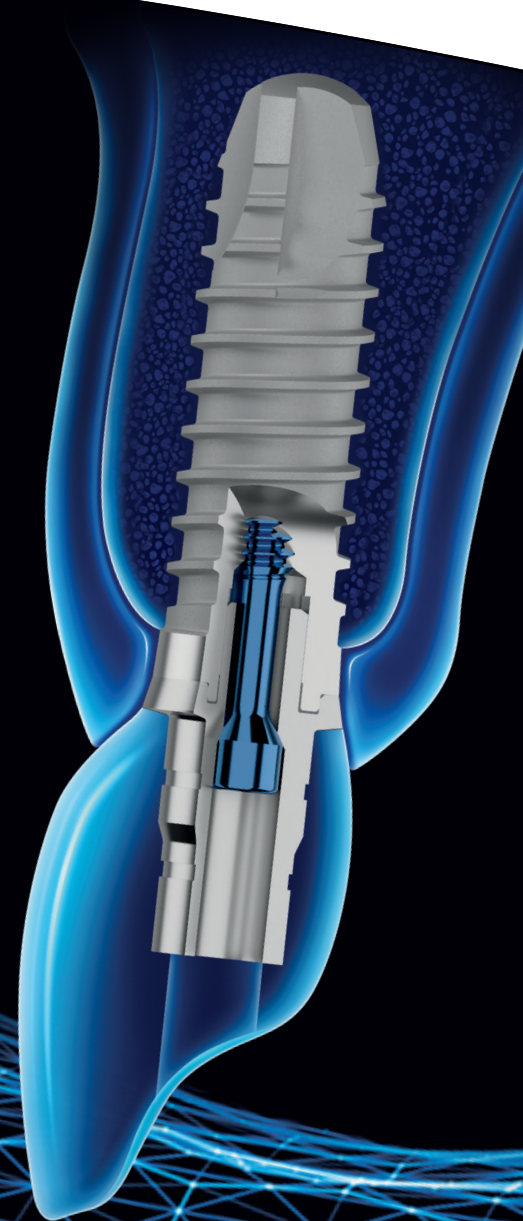

Driven by science, not trends.

The Thommen Dental Implant System

One comprehensive implant system, based on a unique, proven design, optimized over three decades of clinical success with the MULTIGUARD Protection Solution.

THE MULTIGUARD Protection Solution

A combination of innovative features working together to protect implant integrity by maintaining mechanical stability and an optimal bio-response for the life of the patient.



INTEGUARD® Matrix

For optimal hard tissue response

Faster osseointegration is promoted by the implant surface INICELL® which is the superhydrophilic state of the proven sandblasted and thermal acid-etched implant surface.

Photo: © Martin Oeggerli / www.micronaut.ch

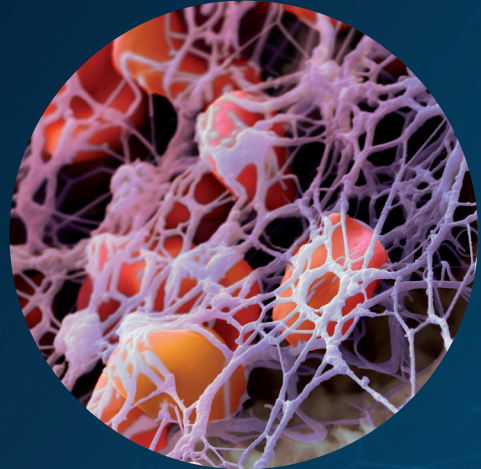

EVERGUARD® Connection

Designed for long-term mechanical stability

The EVERGUARD® Connection with an internal hex and external stabilization ring, ensures optimal long-term mechanical stability of the implant abutment connection.

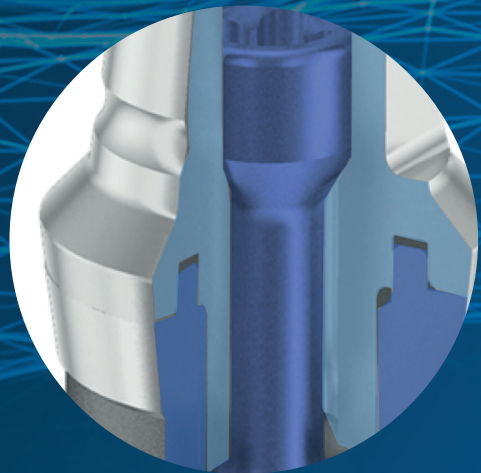

TISSUEGUARD® Collar

For optimal soft tissue response

The TISSUEGUARD® Collar encourages soft tissue adaptation to prevent bone loss and allows for surgical flexibility if needed.

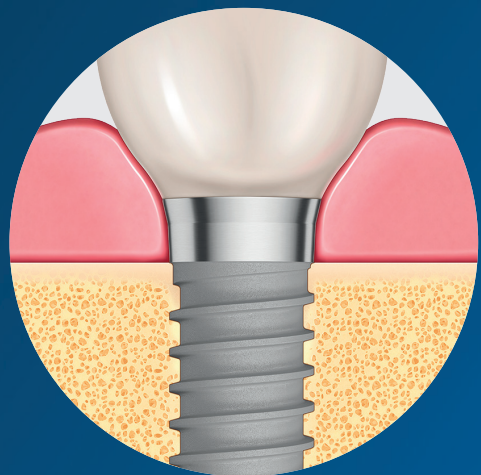

INTEGUARD® Matrix

For optimal hard tissue response

One of the primary features of the INTEGUARD® Matrix is the surface INICELL® which promotes faster osseointegration and results in very low failure rates (1–3).

We produce all Thommen implants from coldworked cp Titanium Grade 4. This material combines mechanical strength with excellent biocompatibility (4). INICELL® is the conditioned state of the sandblasted and thermal acid-etched Thommen implant surface. Conditioning occurs immediately before implantation through contact with the conditioning solution. The result of this process is increased surface energy and improved wettability due to superhydrophilic properties (5), without any change of the clinically proven microroughness of the Thommen implant surface (6–9).

Biologically improved wettability leads to a homogenous adsorption of proteins on the implant surface. This leads to more activated thrombocytes (10) and a homogenous, thicker blood clot network in the early stages of wound healing (11). On the molecular level, MMPs, BMP-2 and VEGF are present in higher concentrations on the INICELL® surface (11, 12), accelerating the osseointegration process.

After 14 days, the INICELL® surface shows 40% more bone-to-implant contact (BIC), in contrast to unconditioned surfaces (13).

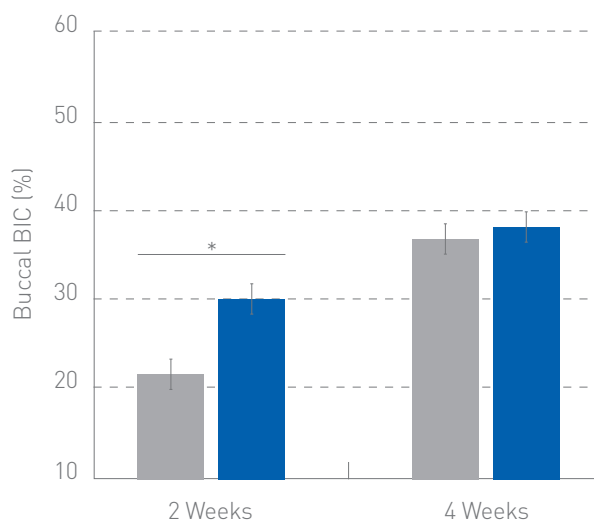

■ Unconditioned Thommen surface

■ INICELL® (conditioned surface)

* Statistically significant (p < 0,001)

40% more buccal BIC on INICELL® implants compared to unconditioned implant in an extraction socket beagle dog model (13).

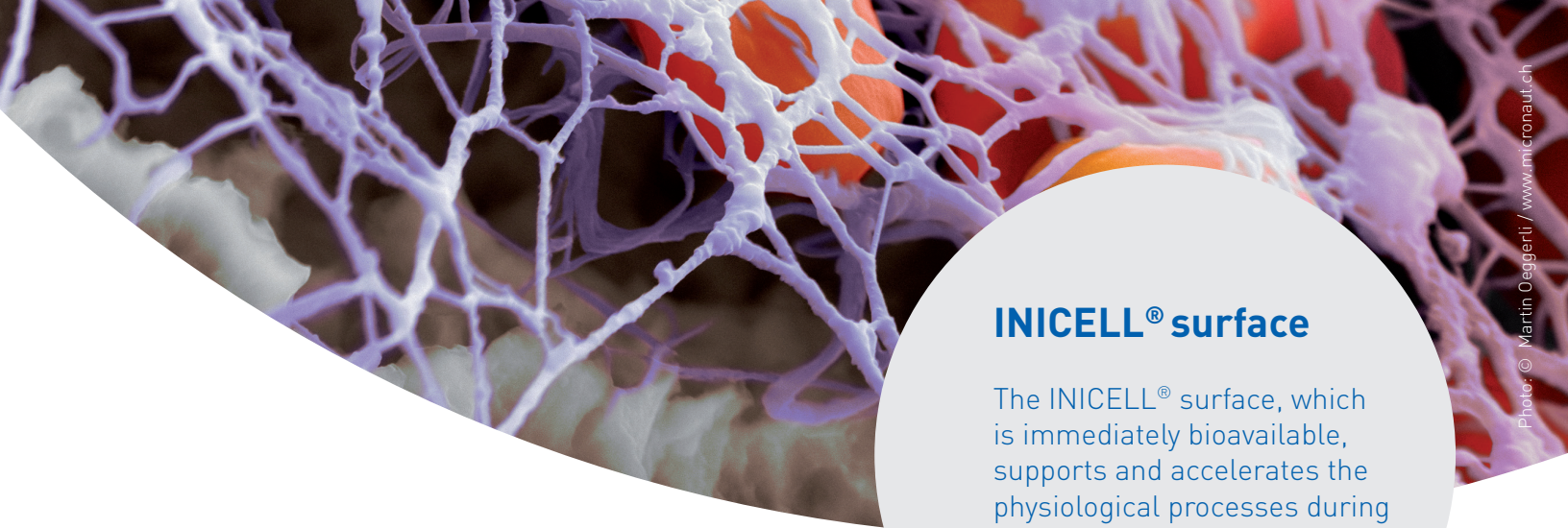
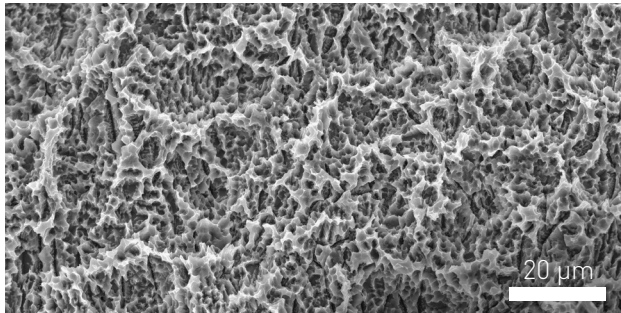

Photo: © Martin Deggerli / www.micronaut.ch

INICELL® surface

The INICELL® surface, which is immediately bioavailable, supports and accelerates the physiological processes during wound healing and early osseointegration.



Scanning electron microscopy (SEM) image of the sandblasted and thermal acid-etched Thommen implant surface.

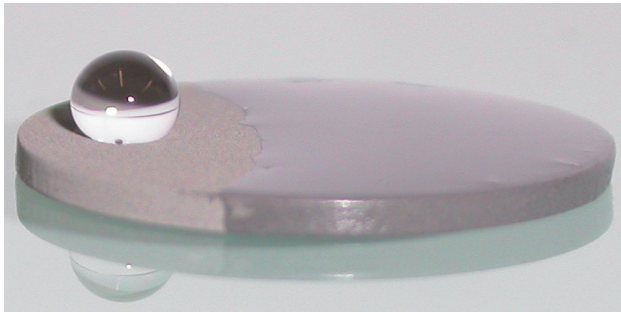

Sandblasted and thermal acid-etched model substrate with water on the unconditioned (left) and conditioned INICELL® (right) surface.

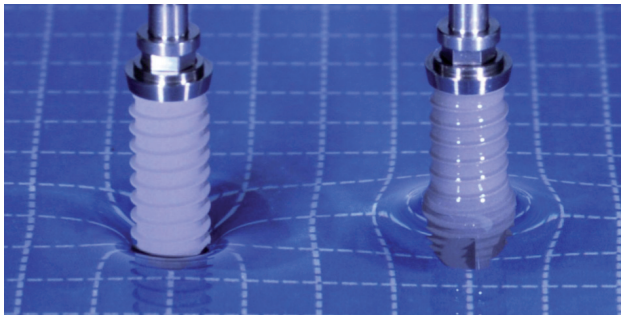

Wetting experiment with an ELEMENT implant with unconditioned surface (left) and INICELL® (right).

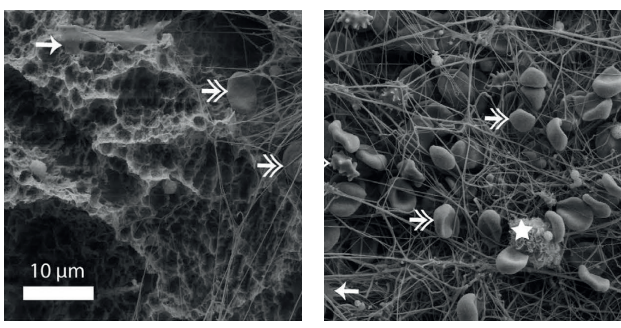

- ★ Leukocyte
- Platelet
- ⇒ RBC

INICELL® enhances blood clot formation on the implant surface. Left: unconditioned surface, Right: INICELL® [11].

The result is faster osseointegration and therefore a shorter healing time of INICELL® implants (1, 14, 15).

This reduces the risk of early failure in the transition from the mechanical primary stability to the biologic long-term secondary stability of osseointegration (2, 16).

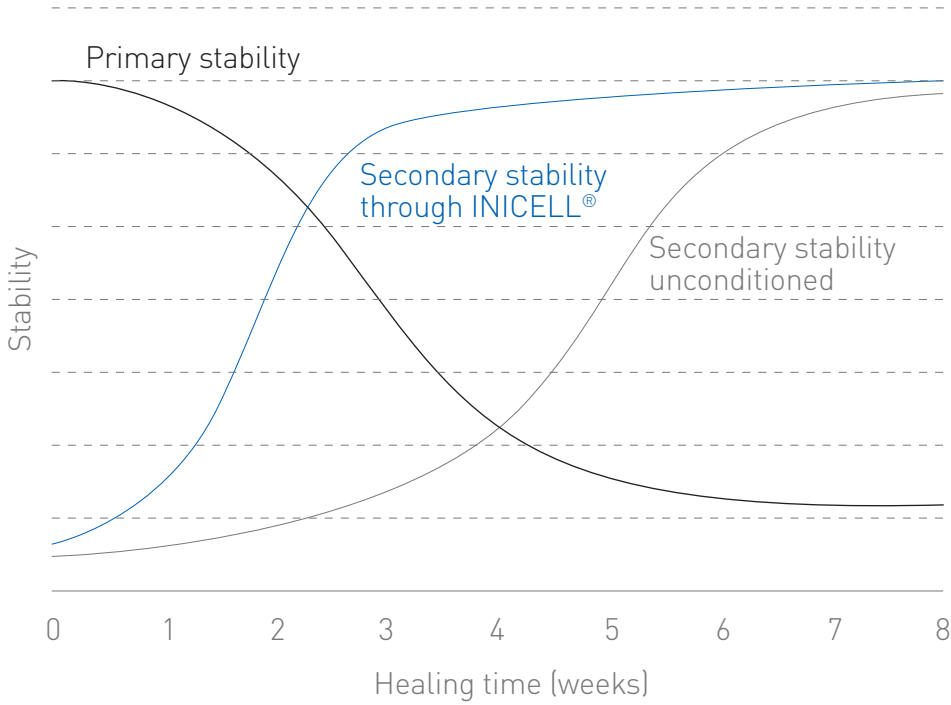

Cumulative Survival Rate (3)

p < 0,001 (Pearson's chi square test)

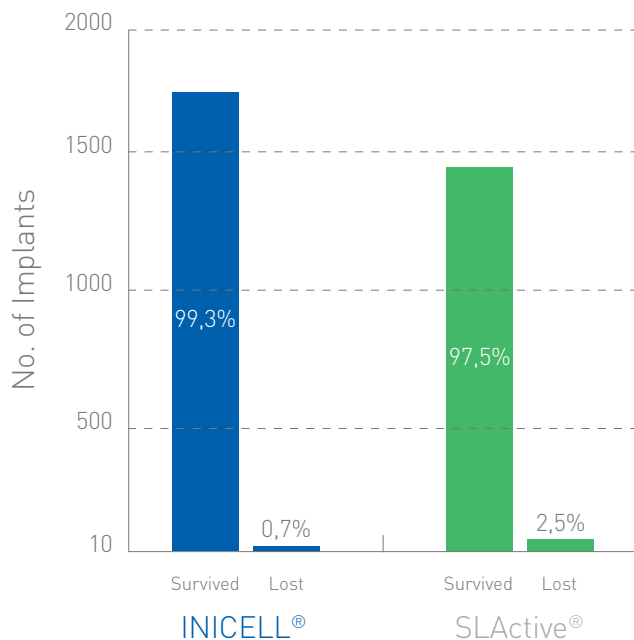

When compared to alternative hydrophilic implants, clinically lower loss rates result with INICELL® (3).

Only with the APLIQUIQ® conditioning system can you generate the alkaline and superhydrophilic surface INICELL® chairside immediately before implantation.

The conditioning solution is stored separately from the implant in the cartridge. By pressing the cartridge and subsequent vigorous shaking, the implant is covered and activated by the conditioning solution.

The conditioning solution is strongly alkaline, with a pH value over 12. The free hydroxyl ions (OH⁻), responsible for the high pH value, have an antimicrobial effect (17, 18).

It protects the implant surface from the removal of the product from the sterile packaging until the first blood contact. The high pH is immediately buffered by the blood, and at the same time the superhydrophilic implant surface allows spontaneous and homogeneous protein adsorption, creating the basis for fast and successful osseointegration.

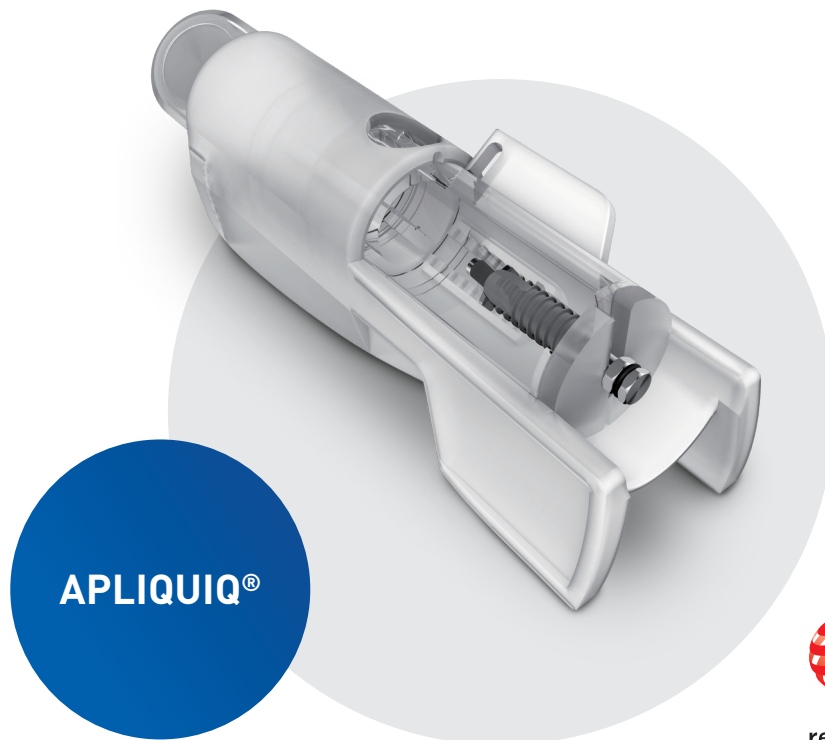
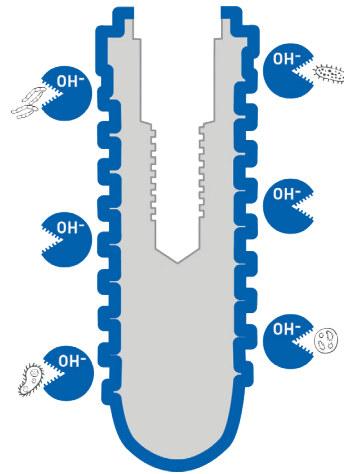

reddot design award



The unique VECTOdrill™, along with the self-tapping implant threads and superhydrophilic INICELL® surface, create the optimal conditions for a reliable osseointegration. The VECTOdrill™ guide tip accurately aligns the subsequent drill with the previous drilled site along the defined drilling axis. The perfect congruence of the implant bed to the core diameter of the implant and the self-tapping implant results in an optimal primary stability.

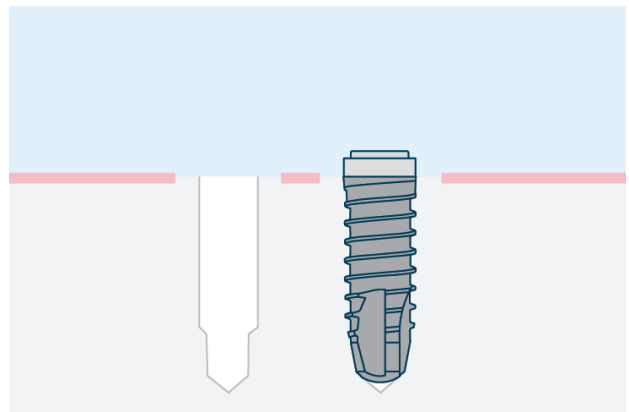
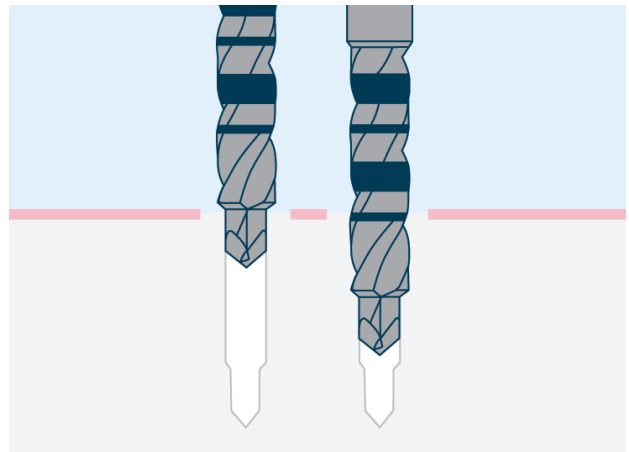

The implant bed preparation with the VECTOdrills™, in combination with the Thommen trapezoidal implant thread profile, creates the optimal condition for primary stability. To achieve the optimal hard tissue response, the preparation of the osteotomy and the perfect fit of the implant are important factors.

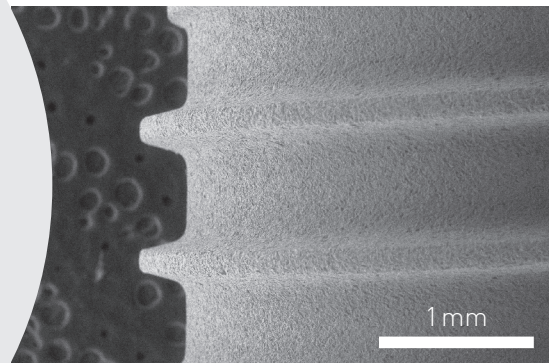

The Thommen guided surgery system provides simple, precise alignment through a cylindrical guidance design. Working in unison with the self-aligning VECTOdrill™, the system is extremely accurate and eliminates the need for separate keys.

The Thommen guided surgery system provides simple handling through instruments with an integrated guidance design.

High flexibility in the digital workflow comes with the compatibility to market leading planning systems.

EVERGUARD® Connection



Designed for long-term mechanical stability

The EVERGUARD® Connection is designed for long-term mechanical stability and has proven itself through more than 35 years of clinical practice. With an internal hex and external stabilization ring, the EVERGUARD® Connection ensures optimal long-term mechanical stability of the implant abutment connection.

The implant abutment connection lies at the heart of any implant system. It is the link between the implant which is anchored in bone and the prosthetic restoration. The implant abutment connection must enable aesthetically pleasing prosthetic restoration and maintenance must be worry free.

The internal hexagon of the EVERGUARD® Connection is manufactured with the highest precision and allows an extremely accurate transfer of the implant position to the master model, which in turn ensures a perfect fit for the prosthesis. The internal hexagon also provides precise rotational orientation and stability for single-tooth implant restorations thanks to the large, indexed contact surfaces.

A unique feature of the EVERGUARD® Connection is the stabilization ring on the implant platform. This stabilization ring self-centers the abutment on the implant and carries the bulk of lateral chewing forces. It gives optimal mechanical stability to the implant abutment connection and minimizes micro-movements at the implant abutment

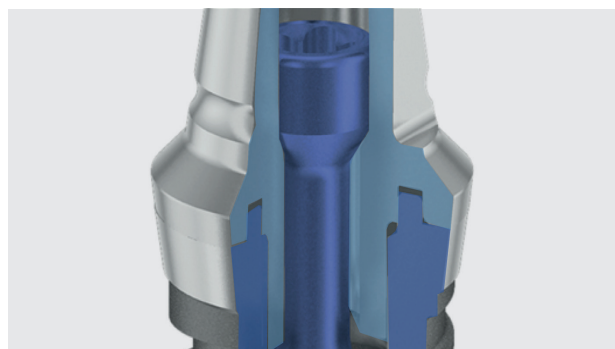
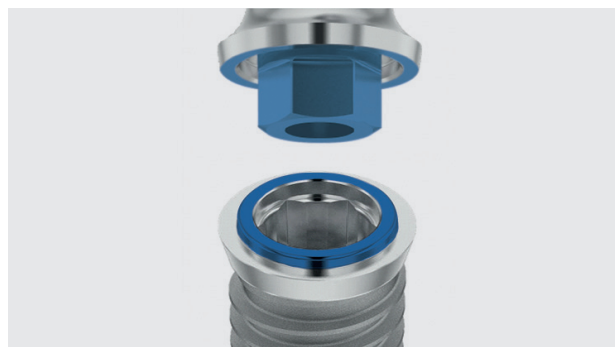

interface close to the bone and soft tissue. Additionally, the stabilization ring focuses the contact area between the implant and abutment so that there is higher surface compression in the critical perimeter area of the connection with comparatively modest torque used on the abutment screw. This minimizes the micro gap between the implant and abutment which reduces the occurrence of bacterial contamination.

The EVERGUARD® Connection design includes an axial stop for consistent abutment position. Axial discrepancies, which can occur with conical connections are avoided and a perfect passive fit can be achieved even for complex multi-unit screw-retained restorations (19). In addition, the axial stop of the EVERGUARD® Connection eliminates the wedge effect observed with conical connection caused by the abutment sinking (20, 21). This wedge effect reduces the preload of the abutment screw, which leads to screw loosening (22).

To compensate for the preload loss caused by the wedge effect in actual clinical practice, the appropriate torque must be applied regularly and repeatedly applied after the functioning of the implant prosthesis (23). The axial stop of the EVERGUARD® Connection preserves the abutment screw's preload.

The EVERGUARD® Connection was well-engineered by using computational and experimental methods. Particular attention was paid to the strength of the implant walls: they must be able to withstand significant torque loads placed on the connection during surgical insertion as well as strong occlusal chewing forces without fear of fracture. For this reason, the dimensions of the EVERGUARD® Connection were calculated and optimized using the finite element analysis, and thoroughly tested to ensure optimal strength and fatigue resistance.

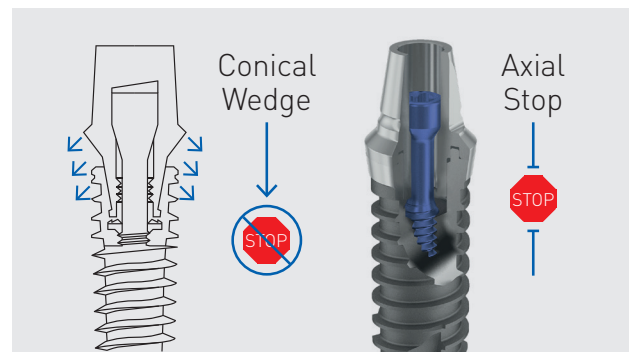

The clever design of the reduced size abutment screw enables thicker implant and abutment walls and protects implant integrity. The abutment screw of the EVERGUARD® Connection has a small screw head with a diameter of 1,6 mm respectively 1,9 mm compared with more typical diameters of 2,2 mm to 2,6 mm. The small screw head is possible because it does not need to withstand the higher clamping forces which other designs may require and it is protected from lateral loads by the stabilization ring. The small screw head allows abutments to be produced with a narrower screw channel and thicker walls. This in turn gives the dental

technician more freedom for prosthetic design and fabrication for a strong and esthetic result.

The abutment screw utilizes a proven reduced diameter shaft (anti-fatigue shaft), a common component in engineering that is used in the design of connections that are subject to strong dynamic loads [24]. An anti-fatigue shaft screw differs from a normal screw in that the shaft is subject to small elastic deformation when exposed to tension and acts like a spring. Tightening the abutment screw imparts a calculated amount of tension ("pre-load") on the shaft which compresses the abutment onto the implant to generate a stable

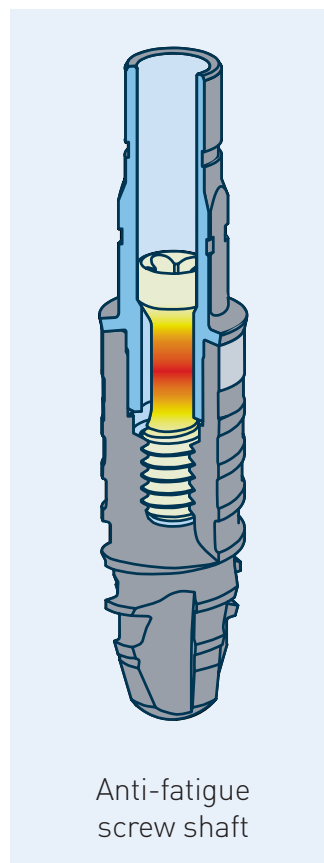
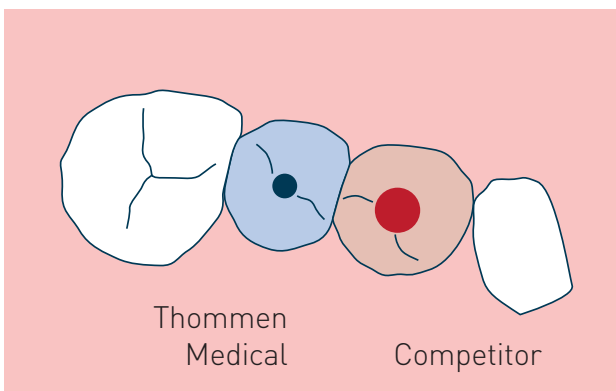
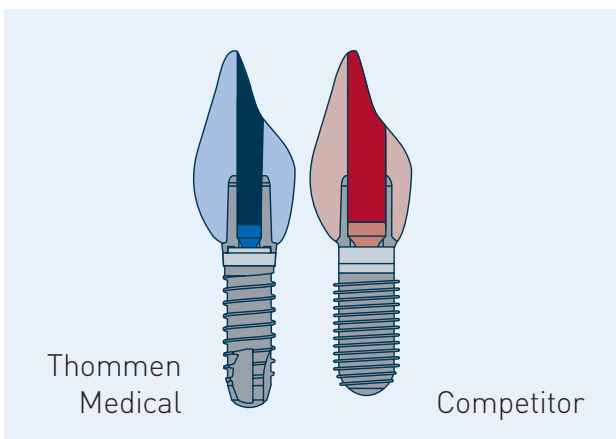

connection. In addition to its physical design, optimal fatigue properties of the abutment screw are ensured by the use of a high-strength titanium alloy (TAN). The selected titanium alloy has excellent biocompatibility and is widely used in orthopedic devices (4).

The appropriate pre-load of the abutment screw is attained by the application of the correct tightening torque with the MONO Torque Ratchet. Conventional ratchets consist of several parts, have recesses and are generally hard to clean.

The MONO Torque Ratchet

The MONO Torque Ratchet from Thommen Medical is manufactured from a solid billet of high-strength titanium alloy which ensures precise control of torque applied and doesn't need to be calibrated or taken apart for sterilization (25,26).

The 4 Lobe Screw interface provides strength for insertion and easy engagement to carry the screw.



reddot design award

TISSUEGUARD® Collar

For optimal soft tissue response

The TISSUEGUARD® Collar encourages soft tissue adaptation to prevent bone loss and allows for surgical flexibility to place the machined collar into the bone depending on the clinical need.

Due to the collar, the implant-abutment connection lies in most cases in the soft tissue, which results in an optimal healing situation for both, the soft tissue and the underlying bone [28]. It also allows for easier impression taking and inserting or replacing the prosthesis.

The machined surface of the collar is optimal for soft tissue and is cleansable [29, 30], which improves hygienic maintenance to reduce the risk of biologic complications including peri-implantitis [29, 31–33]. It is of great benefit over the entire life of the implant that the prosthetic platform is within the soft tissue since the collar and the adjacent soft tissue form a safety zone above the bone [28].

Stable soft tissue adaptation is formed around the machined collar. The straight design of the collar facilitates hygienic maintenance due to good accessibility and visibility [32]. Since the immunologic defense takes place in the soft tissue in the event of inflammation, it is important to manage this safety zone properly over time. The collar acts like a safety belt and enables an easier cleaning.

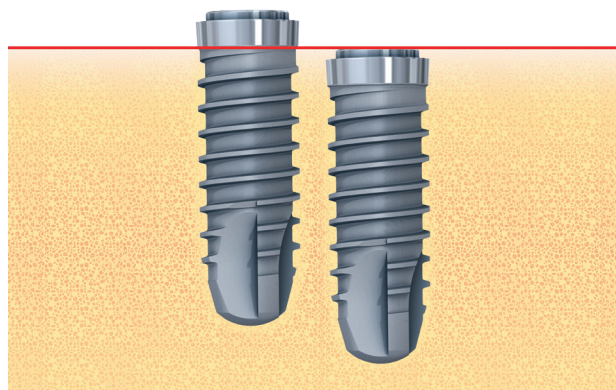
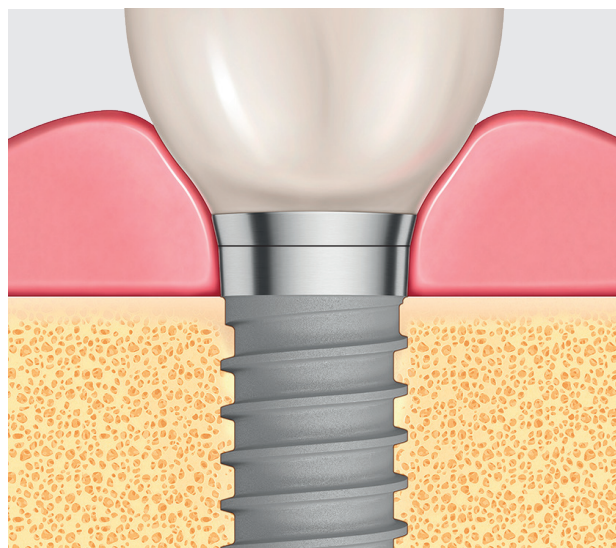

The 1 mm collar of the ELEMENT RC implant allows for surgical flexibility.



When designing the implant-abutment connection, we dedicated special attention to the interface. From a biological point of view, any bacterial colonization is highly undesirable, which is why the interface is manufactured as smooth and precise as possible. The collar-abutment design supports the patient's daily maintenance as well as probing and scaling upon hygiene visits (32).



Definitive restoration



After 10 years

"Due to this perfect connection we notice extremely stable bone conditions."



Dr. Ueli Grunder,
Zurich Zollikon

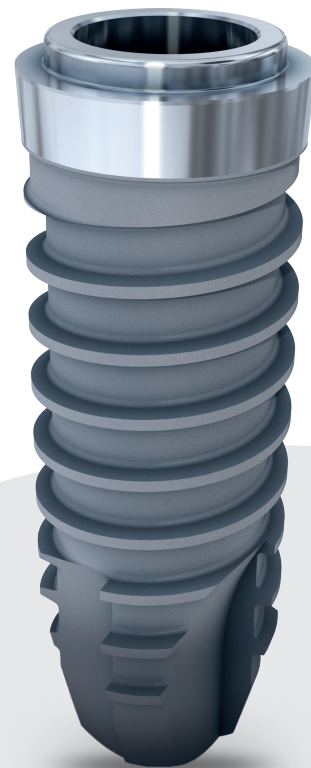

THE MULTIGUARD

Protection Solution

EVERGUARD®
Connection

INTEGUARD®
Matrix

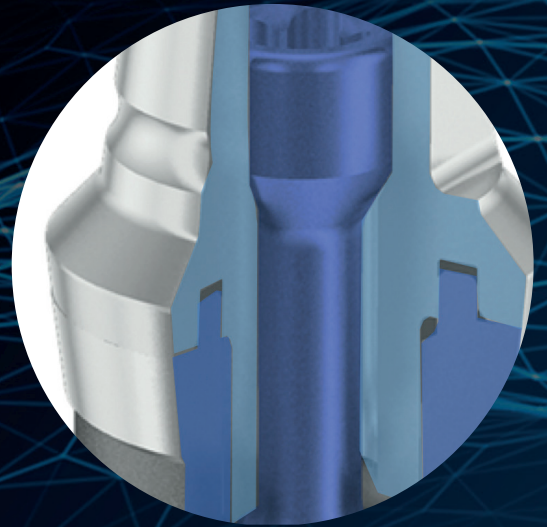
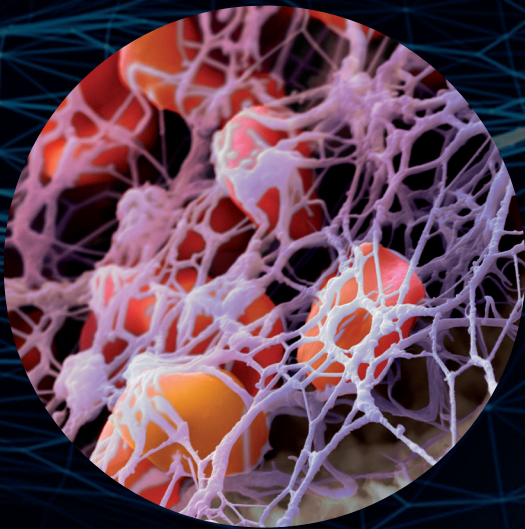

TISSUEGUARD® Collar

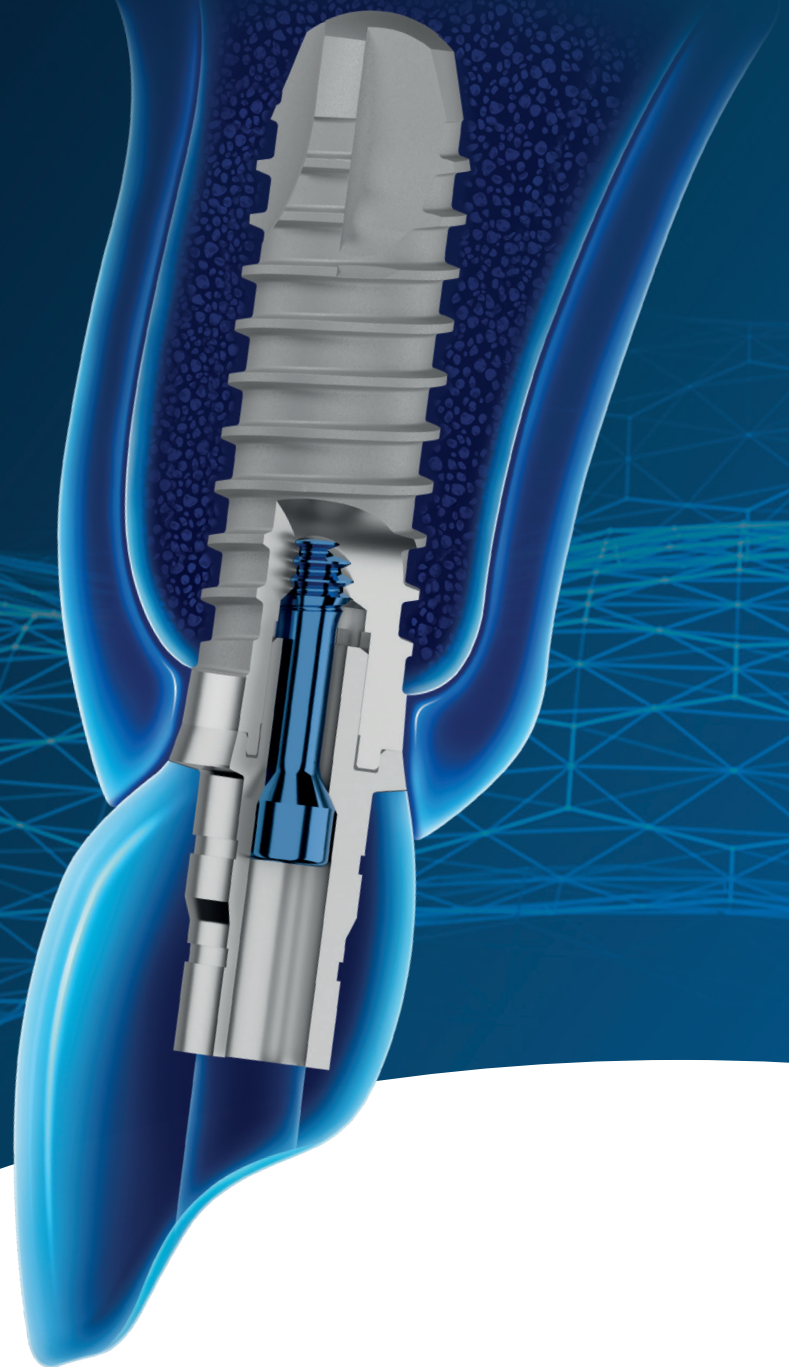
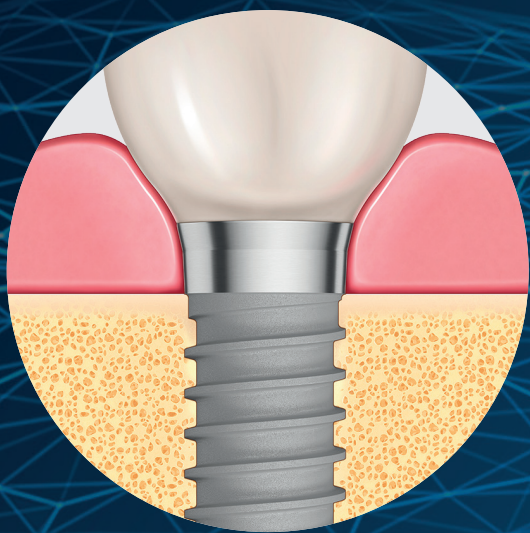

LITERATURE

1. Hicklin SP, Janner SF, Schnider N, Chappuis V, Buser D, Brägger U. Early Loading of Titanium Dental Implants with an Intraoperatively Conditioned Hydrophilic Implant Surface: 3-Year Results of a Prospective Case Series Study. *Int J Oral Maxillofac Implants*. 2020;35(5):1013-20.
2. Gac OL, Grunder U. Six-Year Survival and Early Failure Rate of 2918 Implants with Hydrophobic and Hydrophilic Enossal Surfaces. *Dent J (Basel)*. 2015;3(1):15-23.
3. Makowiecki A, Hadzik J, Błaszczyszyn A, Gedrange T, Dominiak M. An evaluation of superhydrophilic surfaces of dental implants - a systematic review and meta-analysis. *BMC Oral Health*. 2019;19(1):79.
4. Steinemann SG. Titanium — the material of choice? *Periodontology 2000*. 1998;17(1):7-21.
5. Tugulu S, Löwe K, Scharnweber D, Schlottig F. Preparation of superhydrophilic microrough titanium implant surfaces by alkali treatment. *Journal of Materials Science: Materials in Medicine*. 2010;21(10):2751-63.
6. Merli M, Merli M, Mariotti G, Pagliaro U, Moscatelli M, Nieri M. Immediate versus early non-occlusal loading of dental implants placed flapless in partially edentulous patients: A 10-year randomized clinical trial. *J Clin Periodontol*. 2020;47(5):621-9.
7. Jaquiéry C, Ilgenstein B, Jungo M, Rüeeger K, Chenaux S, Papadimitropoulos A, et al. Clinical and Radiological Outcome of Titanium Implants in Clinical Practice: A 5 Year, Prospective, Multicenter Case Series. *Dentistry Journal*. 2014;2:106-17.
8. Gholami H, Mericske-Stern R, Kessler-Liechti G, Katsoulis J. Radiographic bone level changes of implant-supported restorations in edentulous and partially dentate patients: 5-year results. *Int J Oral Maxillofac Implants*. 2014;29(4):898-904.
9. Bäumer D, Zuhr O, Rebele S, Hürzeler M. Socket Shield Technique for immediate implant placement - clinical, radiographic and volumetric data after 5 years. *Clin Oral Implants Res*. 2017;28(11):1450-8.
10. Milleret V, Tugulu S, Schlottig F, Hall H. Alkali treatment of microrough titanium surfaces affects macrophage/monocyte adhesion, platelet activation and architecture of blood clot formation. *Eur Cell Mater*. 2011;21:430-44; discussion 44.
11. Burkhardt MA, Waser J, Milleret V, Gerber I, Emmert MY, Foolen J, et al. Synergistic interactions of blood-borne immune cells, fibroblasts and extracellular matrix drive repair in an in vitro peri-implant wound healing model. *Sci Rep*. 2016;6:21071.
12. Burkhardt MA, Gerber I, Moshfegh C, Lucas MS, Waser J, Emmert MY, et al. Clot-entrapped blood cells in synergy with human mesenchymal stem cells create a pro-angiogenic healing response. *Biomater Sci*. 2017;5(10):2009-23.
13. Calvo-Guirado JL, Ortiz-Ruiz AJ, Negri B, López-Marí L, Rodríguez-Barba C, Schlottig F. Histological and histomorphometric evaluation of immediate implant placement on a dog model with a new implant surface treatment. *Clin Oral Implants Res*. 2010;21(3):308-15.
14. Hinkle RM, Rimer SR, Morgan MH, Zeman P. Loading of titanium implants with hydrophilic endosteal surface 3 weeks after insertion: clinical and radiological outcome of a 12-month prospective clinical trial. *J Oral Maxillofac Surg*. 2014;72(8):1495-502.
15. Held U, Rohner D, Rothamel D. Early loading of hydrophilic titanium implants inserted in low-mineralized (D3 and D4) bone: one year results of a prospective clinical trial. *Head Face Med*. 2013;9:37.

16. Monje A, Ravidà A, Wang HL, Helms JA, Brunski JB. Relationship Between Primary/Mechanical and Secondary/Biological Implant Stability. *Int J Oral Maxillofac Implants*. 2019;34:s7-s23.
17. Mohammadi Z, Dummer PM. Properties and applications of calcium hydroxide in endodontics and dental traumatology. *Int Endod J*. 2011;44(8):697-730.
18. Madigan MM, Bender KS, Buckley DH, Sattley WM, Stahl DA. *Brock Biology of Microorganisms*. 16th ed: Pearson; 2020.
19. Hogg WS, Zulauf K, Mehrhof J, Nelson K. The Influence of Torque Tightening on the Position Stability of the Abutment in Conical Implant-Abutment Connections. *Int J Prosthodont*. 2015;28(5):538-41.
20. Lee JH, Kim DG, Park CJ, Cho LR. Axial displacements in external and internal implant-abutment connection. *Clin Oral Implants Res*. 2014;25(2):e83-9.
21. Flanagan D, Phillips J, Connor M, Dyer T, Kazerounian K. Hoop stress and the conical connection. *J Oral Implantol*. 2015;41(1):37-44.
22. Shin HM, Huh JB, Yun MJ, Jeon YC, Chang BM, Jeong CM. Influence of the implant-abutment connection design and diameter on the screw joint stability. *J Adv Prosthodont*. 2014;6(2):126-32.
23. Huang Y, Wang J. Mechanism of and factors associated with the loosening of the implant abutment screw: A review. *J Esthet Restor Dent*. 2019;31(4):338-45.
24. Muhs D, Wittel H, Jannasch D, Vossiek J. *Roloff/Matek Maschinenelemente*. Vieweg+Teubner Verlag; 2011.
25. Yilmaz B, L'Homme-Langlois E, Beck FM, McGlumphy E. Accuracy of mechanical torque-limiting devices for dental implants after clinical service. *J Prosthet Dent*. 2015;114(3):378-82.
26. Stroosnijder E, Gresnigt MM, Meisberger EW, Cune MS. Loss of Accuracy of Torque Wrenches Due to Clinical Use and Cleaning Procedure: Short Communication. *Int J Prosthodont*. 2016;29(3):253-5.
27. Camarda AJ, Durand R, Benkarim M, Rompre PH, Guertin G, Ciaburro H. Prospective randomized clinical trial evaluating the effects of two different implant collar designs on peri-implant healing and functional osseointegration after 25 years. *Clin Oral Implants Res*. 2020.
28. Sasada Y, Cochran DL. Implant-Abutment Connections: A Review of Biologic Consequences and Peri-implantitis Implications. *Int J Oral Maxillofac Implants*. 2017;32(6):1296-307.
29. Steiger-Ronay V, Merlini A, Wiedemeier DB, Schmidlin PR, Attin T, Sahrman P. Location of unaccessible implant surface areas during debridement in simulated peri-implantitis therapy. *BMC Oral Health*. 2017;17(1):137.
30. Fu JH, Wang HL. Breaking the wave of peri-implantitis. *Periodontol 2000*. 2020;84(1):145-60.
31. Jepsen S, Berglundh T, Genco R, Aass AM, Demirel K, Derks J, et al. Primary prevention of peri-implantitis: managing peri-implant mucositis. *J Clin Periodontol*. 2015;42 Suppl 16:S152-7.
32. Derks J, Håkansson J, Wennström JL, Tomasi C, Larsson M, Berglundh T. Effectiveness of implant therapy analyzed in a Swedish population: early and late implant loss. *J Dent Res*. 2015;94(3 Suppl):44s-51s.
33. Derks J, Schaller D, Håkansson J, Wennström JL, Tomasi C, Berglundh T. Effectiveness of Implant Therapy Analyzed in a Swedish Population: Prevalence of Peri-implantitis. *J Dent Res*. 2016;95(1):43-9.

USA/CANADA

Thommen Medical USA L.L.C.
1375 Euclid Avenue | Suite 450
Cleveland OH 44115 | USA
Phone +1 866 319 9800 (toll free)
Fax +1 216 583 9801
info.us@thommenmedical.com
orders.us@thommenmedical.com

Driven by science, not trends.