

Product catalogue



First of all

Thank you for your interest in our products. Please note that you must comply with the corresponding instructions for use when selecting and utilizing the products listed in the catalog. You can access them online using the THM number printed on the label at: www.ifu-tm.com, at www.thommenmedical.com/de/ueber-uns/download-center, or via the Thommen App (available free of charge for iOS and Android devices). Of course, your Thommen contact partners in our field sales force and back office teams are on hand to help you.

With the new webshop (available in selected markets), you can order our products intuitively, efficiently and with a good overview. Discover the Thommen Medical webshop at www.shop.thommenmedical.com and take advantage of more benefits.



The product configurator shows the components which Thommen Medical recommend for a restoration. Based on the previous configuration (tooth position, implant diameter, etc.) an article list corresponding with the required treatment method is proposed. This facilitates the selection of products and can be used as an additional and efficient aid along with the catalog. You can find the product configurator at: www.thommenmedical.com or download the App directly in the Apple App Store or Google Play Store.



Content

Surgical PF 3.5–6.0

- 4 SPI®ELEMENT INICELL® cylindrical implant
- 5 SPI®CONTACT INICELL® conical-cylindrical implant
- 6 SPI®ELEMENT cylindrical implant
- 6 SPI®CONTACT conical-cylindrical implant
- 7 Surgical planning aids
- 8 Drills and depth gauges

The Thommen PF 3.0 Implant System

- 10 SPI®ELEMENT INICELL® PF 3.0 implant, VARIOunite abutment PF 3.0 and the related tool set

Soft tissue management

- 14,15 Healing caps and gingiva formers
overview – soft tissue management and temporary restoration

Impression taking/analogs

- 16 Impression taking at implant level
- 18 Scan abutment
- 19 Impression taking at abutment level
- 20 Implant analogs
- 21 Abutment analogs

Biomaterials

Country-specific product information on biomaterials can be found at:
www.thommenmedical.com

Prosthetics

- 22 Prosthetic overview PF 3.5
- 24 Prosthetic overview PF 4.0
- 26 Prosthetic overview PF 4.5
- 28 Prosthetic overview PF 5.0
- 30 Prosthetic overview PF 6.0
- 32 SPI®VARIOtemp for temporary restorations
- 33 Titanium Base for CAD/CAM for cemented and screw-retained restorations
- 34 Dynamic Titanium Base for CAD/CAM for angled screw channels
- 35 Milling abutment for CAD/CAM type II for customized abutments
- 36 SPI®VARIOflex for cemented and screw-retained restorations
- 37 SPI®VARIOmulti for screw-retained restorations
- 41 SPI®VARIO for screw-retained restorations
- 43 SPI®EASY for cemented restorations
- 45 SPI®EASY emergence profile for cemented restorations
- 47 SPI®ART for esthetic restorations, cemented and screw-retained
- 49 SPI®RETAIN for hybrid removable dentures
- 51 ZEST® LOCATOR® implant attachment system

Instruments and accessories

- 54 Instruments for mechanical operation
- 54,55 Instruments for manual operation
- 56 Instruments for guided surgery
- 57 Cassettes
- 58 Explantation instruments

Index

- 59 Index by article numbers
- 66 Alphabetical index

- 73 Torque values
- 74 General notes

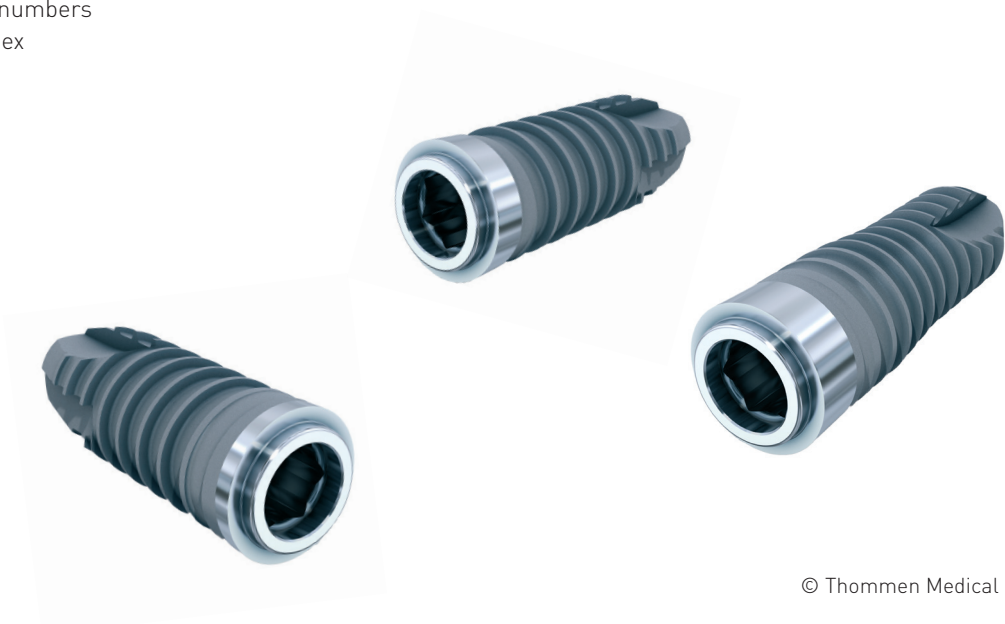

SPI®ELEMENT INICELL®

cylindrical implant

www.ifu-tm.com/THM61112

PF 3.5

PF 4.0

PF 4.5

PF 5.0

PF 6.0

ELEMENT implant RC INICELL®, incl. healing cap, titanium

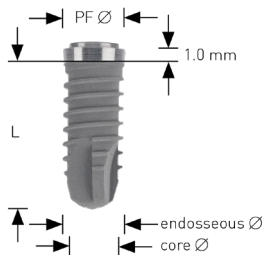

Length	endosseous Ø				
	3.5 mm	4.0 mm	4.2 mm	5.0 mm	6.0 mm
	core Ø				
	2.8 mm	3.5 mm	3.5 mm	4.3 mm	5.3 mm
6.5 mm		4.23.121	4.23.131	4.23.141	4.23.151
8.0 mm	4.23.112	4.23.122	4.23.132	4.23.142	4.23.152
9.5 mm	4.23.113	4.23.123	4.23.133	4.23.143	4.23.153
11.0 mm	4.23.114	4.23.124	4.23.134	4.23.144	4.23.154
12.5 mm	4.23.115	4.23.125	4.23.135	4.23.145	4.23.155
14.0 mm	4.23.116	4.23.126	4.23.136	4.23.146	
17.0 mm	4.23.117		4.23.137		

ELEMENT implant MC INICELL®, incl. healing cap, titanium

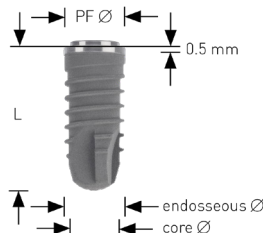

Length	endosseous Ø				
	3.5 mm	4.0 mm	4.2 mm	5.0 mm	6.0 mm
	core Ø				
	2.8 mm	3.5 mm	3.5 mm	4.3 mm	5.3 mm
8.0 mm	4.23.512	4.23.522	4.23.532	4.23.542	4.23.552
9.5 mm	4.23.513	4.23.523	4.23.533	4.23.543	4.23.553
11.0 mm	4.23.514	4.23.524	4.23.534	4.23.544	4.23.554
12.5 mm	4.23.515	4.23.525	4.23.535	4.23.545	4.23.555
14.0 mm	4.23.516	4.23.526	4.23.536	4.23.546	

ELEMENT implant LC INICELL®, incl. healing cap, titanium

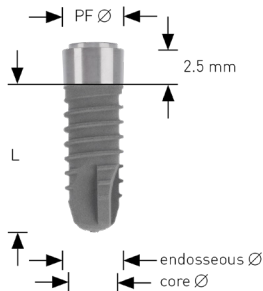

Length	endosseous Ø				
	3.5 mm	4.0 mm	4.2 mm	5.0 mm	6.0 mm
	core Ø				
	2.8 mm	3.5 mm	3.5 mm	4.3 mm	5.3 mm
6.5 mm		4.23.721			
8.0 mm	4.23.712	4.23.722			
9.5 mm	4.23.713	4.23.723			
11.0 mm	4.23.714	4.23.724			
12.5 mm	4.23.715	4.23.725			
14.0 mm	4.23.716	4.23.726			



Healing caps for SPI®ELEMENT INICELL® and SPI®CONTACT INICELL® are included as standard in the delivery (component of the APLIQUIQ).

SPI® CONTACT INICELL®

conical-cylindrical implant

www.ifu-tm.com/THM61112

PF 3.5 PF 4.0 PF 4.5 PF 5.0 PF 6.0

CONTACT implant RC INICELL®, incl. healing cap, titanium

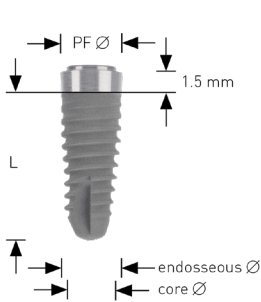

Length	endosseous Ø				
	2.7 mm	3.5 mm	3.5 mm	4.2 mm	5.0 mm
	core Ø				
	2.0 mm	2.8 mm	2.8 mm	3.5 mm	4.3 mm
9.5 mm		4.23.223	4.23.233	4.23.243	4.23.253
11.0 mm	4.23.214	4.23.224	4.23.234	4.23.244	4.23.254
12.5 mm	4.23.215	4.23.225	4.23.235	4.23.245	4.23.255
14.0 mm	4.23.216	4.23.226	4.23.236	4.23.246	4.23.256
17.0 mm			4.23.237	4.23.247	

CONTACT implant MC INICELL®, incl. healing cap, titanium

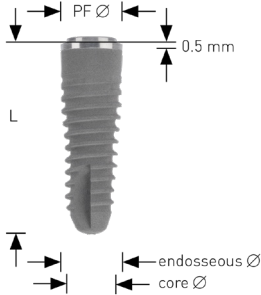

Length	endosseous Ø				
	2.7 mm	3.5 mm	3.5 mm	4.2 mm	5.0 mm
	core Ø				
	2.0 mm	2.8 mm	2.8 mm	3.5 mm	4.3 mm
11.0 mm		4.23.624	4.23.634	4.23.644	4.23.654
12.5 mm	4.23.615	4.23.625	4.23.635	4.23.645	4.23.655
14.0 mm	4.23.616	4.23.626	4.23.636	4.23.646	4.23.656
15.5 mm	4.23.617	4.23.627	4.23.637	4.23.647	4.23.657

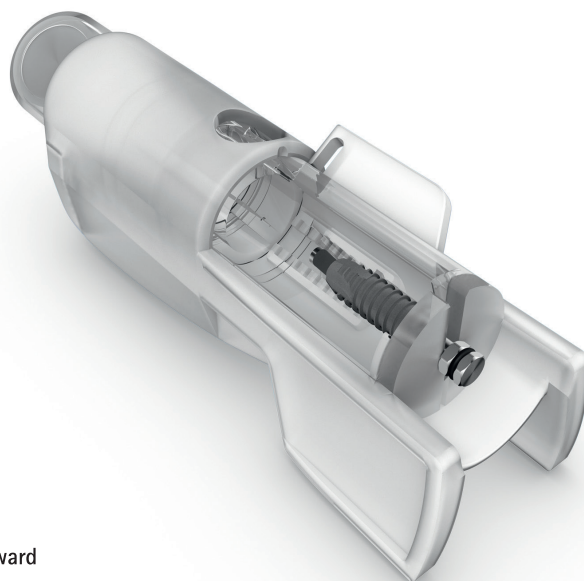

reddot design award
winner 2011

SPI®ELEMENT

cylindrical implant

www.ifu-tm.com/THM61113

PF 3.5

PF 4.0

PF 4.5

PF 5.0

PF 6.0

ELEMENT implant, incl. healing cap, titanium

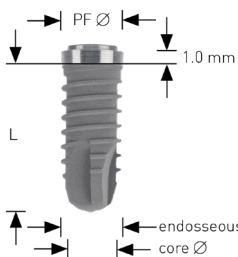

Length

	endosseous Ø	3.5 mm	4.0 mm	4.2 mm	5.0 mm	6.0 mm
	core Ø	2.8 mm	3.5 mm	3.5 mm	4.3 mm	5.3 mm
6.5 mm			4.13.905	4.13.906	4.13.907	4.13.908
8.0 mm		4.13.900	4.13.904	4.13.901	4.13.902	4.13.903
9.5 mm		4.13.940	4.13.914	4.13.941	4.13.942	4.13.943
11.0 mm		4.13.910	4.13.924	4.13.911	4.13.912	4.13.913
12.5 mm		4.13.950	4.13.934	4.13.951	4.13.952	4.13.953
14.0 mm		4.13.920	4.13.944	4.13.921	4.13.922	
17.0 mm		4.13.930		4.13.931		

SPI® CONTACT

conical-cylindrical implant

www.ifu-tm.com/THM61113

CONTACT implant, incl. healing cap, titanium

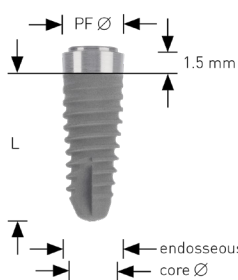

Length

	endosseous Ø	2.7 mm	3.5 mm	3.5 mm	4.2 mm	5.0 mm
	core Ø	2.0 mm	2.8 mm	2.8 mm	3.5 mm	4.3 mm
9.5 mm			4.13.214	4.13.211	4.13.212	4.13.213
11.0 mm		4.13.220	4.13.224	4.13.221	4.13.222	4.13.223
12.5 mm		4.13.230	4.13.234	4.13.231	4.13.232	4.13.233
14.0 mm		4.13.240	4.13.244	4.13.241	4.13.242	4.13.243
17.0 mm				4.13.261	4.13.262	



The healing caps for SPI®ELEMENT and SPI®CONTACT are included in delivery.

Surgical planning aids

www.ifu-tm.com/THM61141

SPI®ELEMENT

X-ray template, for planning with two-dimensional x-ray devices

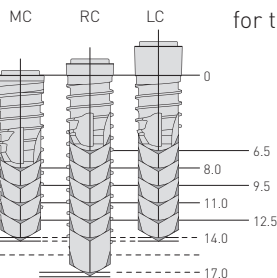

for the ELEMENT implant line

Fo_20d184

SPI®CONTACT

for the CONTACT implant line

Fo_20d185

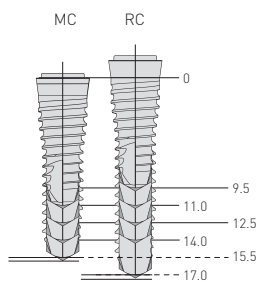

X-ray reference sphere, stainless steel



∅
5.0 mm

3.03.140

Guiding sleeve for VECTOdrill™ pilot drill, stainless steel, 4 per pack (Q4)



Length Internal ∅
6.0 mm 2.0 mm

3.03.141 Q4

Instructions for digital planning aids can be found at: www.thommenmedical.com

Drills and depth gauges

www.ifu-tm.com/THM61141

VECTOdrill™ twist drill, single use, sterile packed, stainless steel, 4 per pack (Q4)

Length	Pilot drill				
	Ø 2.0 mm	Ø 2.8 mm	Ø 3.5 mm	Ø 4.3 mm	Ø 5.3 mm
29.0 mm extra short*	3.03.624 Q4	3.03.625 Q4	3.03.626 Q4	3.03.627 Q4	3.03.628 Q4
34.0 mm short	3.03.610 Q4	3.03.612 Q4	3.03.614 Q4	3.03.616 Q4	3.03.618 Q4
40.0 mm long	3.03.611 Q4	3.03.613 Q4	3.03.615 Q4	3.03.617 Q4	

* The VECTOdrill™ twist drills, extra short, can only be used with implants of 6.5–14.0 mm in length.

VECTOdrill™ ceramic twist drill, reusable, ceramic

Length	Pilot drill				
	Ø 2.0 mm	Ø 2.8 mm	Ø 3.5 mm	Ø 4.3 mm	Ø 5.3 mm
29.0 mm extra short*	3.03.660	3.03.662	3.03.664	3.03.666	3.03.668
34.0 mm short	3.03.661	3.03.663	3.03.665	3.03.667	3.03.669

* The VECTOdrill™ twist drills, extra short, can only be used with implants of 6.5–14.0 mm in length.

VECTOdrill™ drill, reusable, stainless steel

Length	Pilot drill				
	Ø 2.0 mm	Ø 2.8 mm	Ø 3.5 mm	Ø 4.3 mm	Ø 5.3 mm
29.0 mm extra short*	3.03.710	3.03.712	3.03.714	3.03.716	3.03.718
34.0 mm short	3.03.720	3.03.722	3.03.724	3.03.726	3.03.728
40.0 mm long	3.03.730	3.03.732	3.03.734	3.03.736	

* The VECTOdrill™ twist drills, extra short, can only be used with implants of 6.5–14.0 mm in length.

VECTOdrill™ depth gauge titanium

Length	Ø 2.0 mm	Ø 2.8 mm	Ø 3.5 mm	Ø 4.3 mm	Ø 5.3 mm
27.5 mm	3.03.630	3.03.632	3.03.634	3.03.636	3.03.638

Drill Ø 1.5 mm, single use, sterile packed, stainless steel, 4 per pack (Q4)

Length	
34.0 mm short	3.03.690 Q4

Drill Ø 1.5 mm, reusable, stainless steel

Length	
34.0 mm short	3.03.790

Depth gauge Ø 1.5 mm, customizable length, titanium

Length	
30.5 mm	3.03.692

PF 3.5

PF 4.0

PF 4.5

PF 5.0

PF 6.0

SPI®ELEMENT profile drill, single use, sterile packed, stainless steel, 4 per pack (Q4)

Length

29.0 mm	extra short	3.03.651 Q4	3.03.657 Q4	3.03.653 Q4	3.03.655 Q4	3.03.659 Q4
---------	-------------	--------------------	--------------------	--------------------	--------------------	--------------------

SPI®CONTACT profile drill, single use, sterile packed, stainless steel, 4 per pack (Q4)

Length

29.0 mm	extra short	3.03.641 Q4	3.03.649 Q4	3.03.643 Q4	3.03.645 Q4	3.03.647 Q4
---------	-------------	--------------------	--------------------	--------------------	--------------------	--------------------



34.0 mm	short	3.03.640 Q4	3.03.648 Q4	3.03.642 Q4	3.03.644 Q4	3.03.646 Q4
---------	-------	--------------------	--------------------	--------------------	--------------------	--------------------

Thread tap, reusable, stainless steel

Length

	endosseous Ø	3.5 mm	4.0 mm	4.2 mm	5.0 mm	6.0 mm
34.0 mm		3.03.680	3.03.682	3.03.684	3.03.686	3.03.688

Bone contouring instrument, reusable, stainless steel

Length

29.0 mm	3.03.671	3.03.673	3.03.675	3.03.677	3.03.679
---------	-----------------	-----------------	-----------------	-----------------	-----------------

Bone contouring instrument+, reusable, stainless steel

Length

29.0 mm	3.03.670	3.03.672	3.03.674	3.03.676	
---------	-----------------	-----------------	-----------------	-----------------	--

For the angled VARIOmulti abutment.

Drill extension, stainless steel

Length External Ø

26.0 mm	3.7 mm	3.03.231			
---------	--------	-----------------	--	--	--



26.0 mm	5.0 mm		3.03.230		
---------	--------	--	-----------------	--	--



Mucosa punch, reusable, stainless steel

Length

27.0 mm	3.03.315	3.03.316	3.03.320	3.03.317	3.03.318
---------	-----------------	-----------------	-----------------	-----------------	-----------------

SPI®ELEMENT INICELL® PF 3.0

implant, VARIO unite abutment PF 3.0 and the related tool set,
www.ifu-tm.com/THM61146

 Rotation locked
 Rotation unlocked

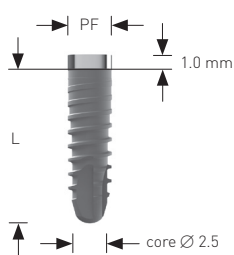

ELEMENT implant RC INICELL® PF 3.0, incl. healing cap, titanium

Length	core Ø	
8.0 mm	2.5 mm	4.23.102
9.5 mm		4.23.103
11.0 mm		4.23.104
12.5 mm		4.23.105

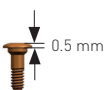

The healing caps for SPI®ELEMENT INICELL® are included as standard in delivery (component of APLIQUIQ).

Gingiva former for PF 3.0, 4-lobe, titanium

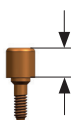

Height	
3.2 mm	4.03.538
4.5 mm	4.03.548
7.0 mm	4.03.558

SPI®ELEMENT INICELL®PF 3.0

X-ray template, for planning with two-dimensional x-ray devices

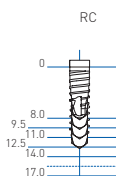

for the ELEMENT implant line

Fo_20d184

VECTOdрил™ pilot drill, reusable, stainless steel



Length		Pilot drill
40.0 mm	long	Ø 2.0 mm 3.03.730

VECTOdрил™ pilot drill, single use, sterile packed, stainless steel, 4 per pack unit (Q4)





Length		Pilot drill
40.0 mm	long	Ø 2.0 mm 3.03.611 Q4

SPI®ELEMENT profile drill for PF 3.0, single use, sterile packed, stainless steel



For implant lengths	8.0 mm	9.5 mm	11.0 mm	12.5 mm
	3.03.740	3.03.741	3.03.742	3.03.743

-  Rotation locked
 Rotation unlocked

Bone contouring instrument for PF 3.0, reusable, stainless steel



Length
29.0 mm **3.03.658**

Adapter for hand piece PF 3.0, stainless steel



Length
28.0 mm **3.03.238**

Adapter for hand piece, one-piece, stainless steel



Length
24.0 mm **3.03.248**

 **VARIOunite abutment PF 3.0 for crown, incl. abutment screw, titanium alloy**



Height
12.0 mm **1.04.138**

 **VARIOunite burn-out plastic cap, PF 3.0, POM**

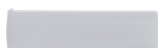

Height
11.8 mm **2.03.848**

Laboratory cylindrical pin, PTFE, 5 per pack (Q5)



Length
70.0 mm **2.03.450 Q5**

 **Impression coping PF 3.0 for open tray technique, reusable, retentive, screw-retained, titanium**



External Ø 3.3 mm
cylindrical, height 16.0 mm **3.04.028**

Screw for impression copings, reusable, 4-lobe, stainless steel





Length
12.5 mm extra short **3.03.572**



21.5 mm long **3.03.574**



27.5 mm extra long **3.03.580**

-  Rotation locked
-  Rotation unlocked

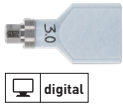

 **Scan abutment**, stainless steel, coated, PF 3.0

Height
 10.0 mm **3.03.774**

Selection of appropriate screw length:

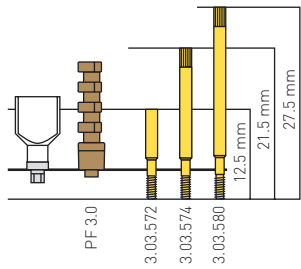

 **Implant analog for CAD/CAM**, titanium, PF 3.0

Length
 11.0 mm **3.03.084**

Implant analogs for CAD/CAM are used for 3D-printed models.



Insertion device for implant analog for CAD/CAM, stainless steel

Length
 35.0 mm **3.03.158**



 **Implant analog PF 3.0**, titanium

Length
 14.0 mm **3.03.098**



Abutment screw, 4-lobe, titanium alloy



Length
 5.8 mm **4.03.500**

Healing caps and gingiva formers

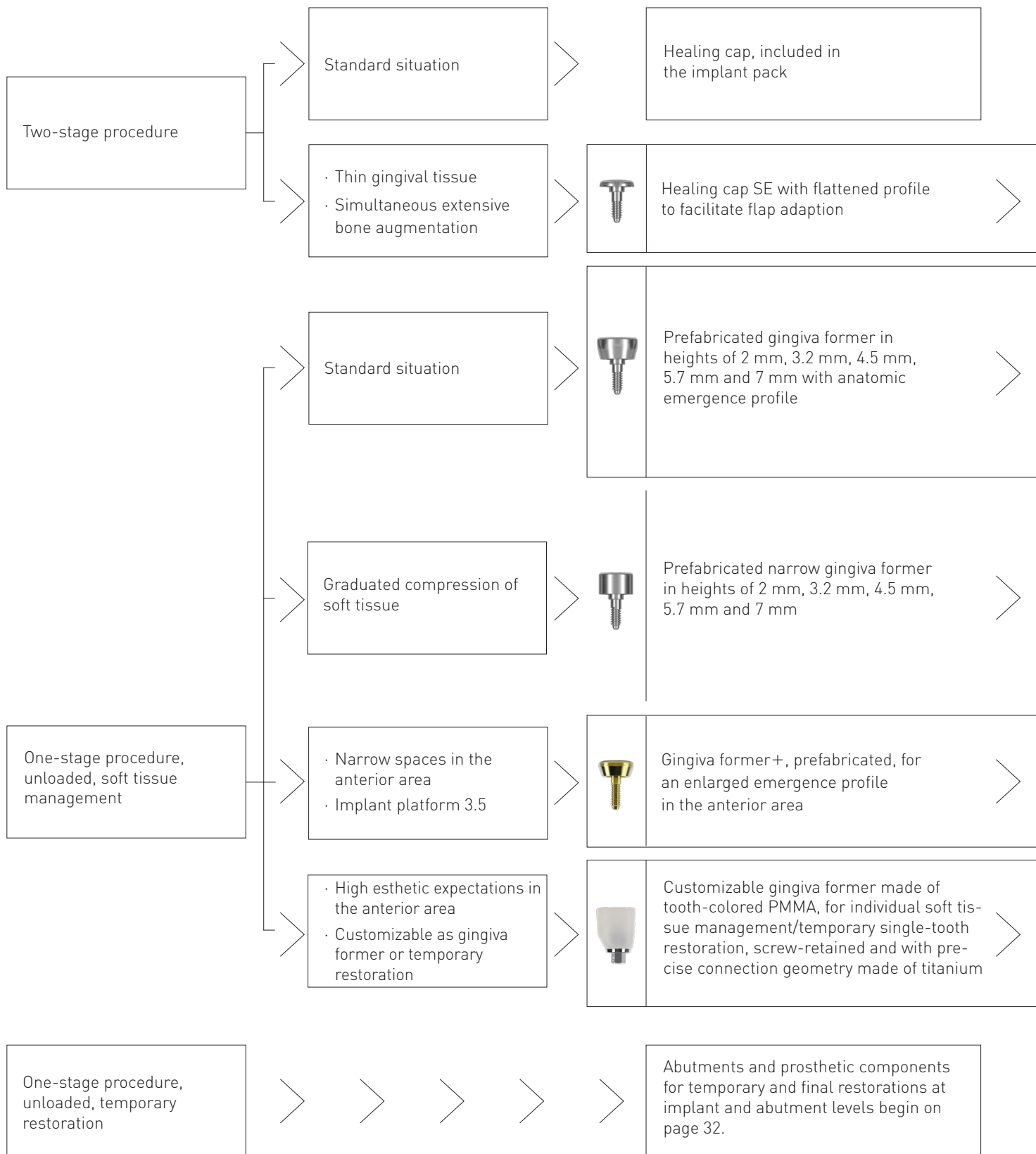
Overview – soft tissue management and temporary restoration



At the abutment level: The temporary caps of the EASY (see page 44, 46, 48) and VARIOmulti (see page 39) abutment lines offer the possibility to fabricate a provisional cap already on the final abutment.

 Rotation locked
 Rotation unlocked
 x.xx.xxxS Sterile packed

PF 3.5	PF 4.0	PF 4.5	PF 5.0	PF 6.0
--------	--------	--------	--------	--------

 **Healing cap SE**, titanium, sterile

Height

1.0 mm	4.03.515S	4.03.519S	4.03.516S	4.03.517S	4.03.518S
--------	-----------	-----------	-----------	-----------	-----------

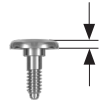

 **Gingiva former**, titanium, sterile

Height

2.0 mm	4.03.520S	4.03.524S	4.03.521S	4.03.522S	4.03.523S
3.2 mm	4.03.530S	4.03.534S	4.03.531S	4.03.532S	4.03.533S
4.5 mm	4.03.540S	4.03.544S	4.03.541S	4.03.542S	4.03.543S
5.7 mm	4.03.560S	4.03.564S	4.03.561S	4.03.562S	4.03.563S
7.0 mm	4.03.550S	4.03.554S	4.03.551S	4.03.552S	4.03.553S

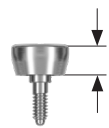

 **Gingiva former narrow**, titanium, sterile

Height

2.0 mm	4.04.310S	4.04.311S	4.04.312S	4.04.313S	4.04.314S
3.2 mm	4.04.320S	4.04.321S	4.04.322S	4.04.323S	4.04.324S
4.5 mm	4.04.330S	4.04.331S	4.04.332S	4.04.333S	4.04.334S
5.7 mm	4.04.340S	4.04.341S	4.04.342S	4.04.343S	4.04.344S
7.0 mm	4.04.350S	4.04.351S	4.04.352S	4.04.353S	4.04.354S

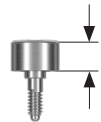

 **Gingiva former+**, titanium, sterile

Height

2.0 mm	4.03.525S				
3.2 mm	4.03.535S				

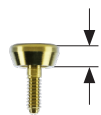

 **Gingiva former**, customizable, titanium/PMMA-based plastic

Height

7.5 mm	4.03.570	4.03.571	4.03.572	4.03.573	4.03.574
--------	----------	----------	----------	----------	----------

Abutment screw is not included in delivery.



Fabrication screw, 4-lobe, customizable for gingiva former and VARIOtemp abutment, stainless steel, 4 per pack unit (Q4)

Length

22.5 mm	3.03.590 Q4				
23.4 mm		3.03.591 Q4			



Abutment screw, 4-lobe, titanium alloy



Length

5.8 mm	4.03.500				
7.2 mm		4.03.501			
10.2 mm		4.03.502			



Impression taking at implant level

www.ifu-tm.com/THM61127

 Rotation locked
 Rotation unlocked

PF 3.5

PF 4.0

PF 4.5

PF 5.0

PF 6.0

Important The screws for impression copings at implant levels are not included in the delivery of impression copings.

Impression coping for closed tray technique, single use, repositionable, screw-retained, aluminum, anodized



Height

External Ø	3.9 mm	5.0 mm	5.5 mm	6.0 mm	7.0 mm
8.0 mm short	3.03.074	3.03.079	3.03.075	3.03.076	3.03.077

Impression coping for closed tray technique, reusable, repositionable, screw-retained, titanium



Height

External Ø	3.9 mm	5.0 mm	5.5 mm	6.0 mm	7.0 mm
8.0 mm short	3.04.030	3.04.031	3.04.032	3.04.033	3.04.034

Screws for impression coping for closed tray technique, extra short



Length

12.5 mm extra short	3.03.572				
13.2 mm extra short				3.03.575	

Impression coping for closed tray technique, single use, repositionable, screw-retained, aluminum, anodized



Height

External Ø	3.9 mm	5.0 mm	5.5 mm	6.0 mm	7.0 mm
12.0 mm long	3.03.014	3.03.019	3.03.015	3.03.016	3.03.017

Impression coping for closed tray technique, reusable, repositionable, screw-retained, titanium



Height

External Ø	3.9 mm	5.0 mm	5.5 mm	6.0 mm	7.0 mm
12.0 mm long	3.04.046	3.04.047	3.04.048	3.04.049	3.04.050

Screws for impression coping for closed tray technique, short



Length

16.5 mm short	3.03.573				
17.2 mm short				3.03.576	



Positioning handle, stainless steel



Length

17.0 mm	6.0 mm	3.03.522 *
---------	--------	------------

* The positioning handle (art. no. 3.03.522) may be used for all impression copings at implant level (except impression copings 16.0 mm in height).

 Rotation locked
 Rotation unlocked

PF 3.5

PF 4.0



PF 4.5

PF 5.0

PF 6.0

 **Impression coping** for open tray technique, single use, retentive, screw-retained, aluminum, anodized

Height

	external-Ø	3.8 mm	4.3 mm	4.8 mm	5.3 mm	6.3 mm
 cylindrical 10.0 mm		3.03.010	3.03.018	3.03.011	3.03.012	3.03.013
 conical 10.0 mm			3.03.078	3.03.071	3.03.072	3.03.073

Positioning handle, stainless steel





Length	Ø	
17.0 mm	6.0 mm	3.03.522 *









* The positioning handle [art. no. 3.03.522] may be used for all impression copings at implant level (except for impression copings 16.0 mm in height).

 **Impression coping** for open tray technique, reusable, retentive, screw-retained, titanium

Height

	external-Ø	3.8 mm	4.3 mm	4.8 mm	5.3 mm	6.3 mm
 cylindrical 16.0 mm		3.04.020	3.04.021	3.04.022	3.04.023	3.04.024
 conical 16.0 mm			3.04.037	3.04.038	3.04.039	3.04.040

Screws for impression copings, reusable, 4-lobe, stainless steel

Length					
 12.5 mm	extra short	3.03.572			
 16.5 mm	short	3.03.573			
 21.5 mm	long	3.03.574			
 27.5 mm	extra long	3.03.580			
 13.2 mm	extra short			3.03.575	
 17.2 mm	short			3.03.576	
 22.2 mm	long			3.03.577	
 28.2 mm	extra long			3.03.581	

Selection of appropriate screw length:

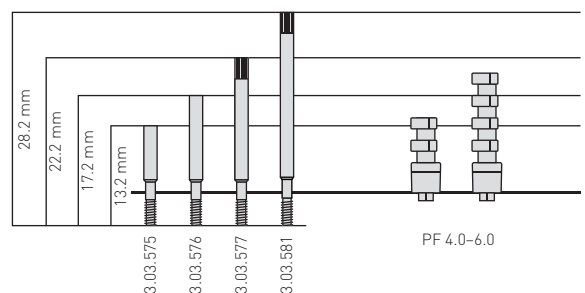
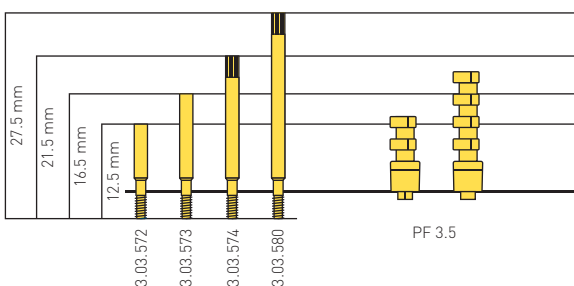

Scan abutments

www.ifu-tm.com/THM61143

Rotation locked
Rotation unlocked

PF 3.5

PF 4.0

PF 4.5

PF 5.0

PF 6.0



digital

Scan abutment, stainless steel, coated

Height

10.0 mm

3.03.775

3.03.776

3.03.777

3.03.778

3.03.779

Screw for impression copings, reusable, 4-lobe, stainless steel

Length

12.5 mm extra short

3.03.572

13.2 mm extra short

3.03.575



Important Thommen Medical provides the corresponding CAD libraries. You can find an overview at: www.thommenmedical.com.



digital

VARIOmulti, scan abutment, titanium, 4-lobe

Height

8.0 mm

3.03.780



digital

VARIOmulti, scan abutment, short, titanium, 4-lobe

Height

5.0 mm



3.03.781

No additional screws are necessary for the attachment of VARIOmulti scan abutments.

The VARIOmulti scan abutments should be used as follows:

- Laboratory scan: long scan abutment (3.03.780)
- Intraoral scan with neighboring teeth: long scan abutment (3.03.780)
- Intraoral scan without neighboring teeth: short scan abutment (3.03.781), as long as the laser marking projects above the gingiva.

Impression taking at abutment level

 Rotation locked
 Rotation unlocked

PF 3.5	PF 4.0	PF 4.5	PF 5.0	PF 6.0
--------	--------	--------	--------	--------

Thommen Medical offers impression copings for impression taking at abutment level for the EASY, VARIOmulti implant lines, as well as for the LOCATOR® and bar abutments. Temporary and protective caps are available for the temporary restoration of EASY and VARIOmulti abutments (see pages 38, 44, 46, 48).

 **EASY impression coping**, plastic



Height	Cone	PF 3.5	PF 4.0	PF 4.5	PF 5.0	PF 6.0
9.5 mm	4.0 mm	2.03.700	2.03.708	2.03.701	2.03.702	2.03.703
11.5 mm	6.0 mm	2.03.704	2.03.709	2.03.705	2.03.706	2.03.707

 **Important** Not suitable for EASY abutment 20°.

 **VARIOmulti impression coping***, titanium



Height	Ø	Part No.
18.0 mm	5.3 mm	3.04.805

* Use the yellow screws for impression copings PF 3.5 (art. nos. 3.03.572, 3.03.573, 3.03.574, 3.03.580) to attach the VARIOmulti impression copings, see p. 38.

 **Impression coping for bar**, aluminum, anodized/plastic





Height	Ø	Part No.
5.0 mm	6.0 mm	3.03.101

 **LOCATOR® impression coping**, aluminum/LDPE, 4 per pack



8505

Implant analogs

 Rotation locked
 Rotation unlocked

PF 3.5

PF 4.0

PF 4.5

PF 5.0

PF 6.0

Implant analogs, titanium



Length

14.0 mm	3.03.090	3.03.095	3.03.091	3.03.092	3.03.093*
22.0 mm	3.03.060	3.03.061	3.03.065	3.03.062	3.03.063

Implant analogs are used for impression taking with impression copings at the implant level.

* Due to design requirements the overall length is 15.0 mm

Implant analogs for CAD/CAM, titanium



Length

11.4 mm	3.03.085	3.03.086	3.03.087	3.03.088	3.03.089
---------	----------	----------	----------	----------	----------

Implant analogs for CAD/CAM are used for 3D-printed models.

Insertion device for implant analog for CAD/CAM, stainless steel



Length

35.0 mm	3.03.158				
35.0 mm		3.03.159			

Handle for dental laboratory, brass/steel





Length

120.0 mm	3.03.250
----------	----------

 **Important** Thommen Medical provides the corresponding CAD libraries. You can find an overview at: www.thommenmedical.com.

Abutment analogs

 Rotation locked
 Rotation unlocked

PF 3.5

PF 4.0

PF 4.5

PF 5.0

PF 6.0

Abutment analogs are only used for impression taking using an impression coping at abutment level. The abutment analogs are also available for the individual abutment lines.

EASY analog, stainless steel



Height	Cone	PF 3.5	PF 4.0	PF 4.5	PF 5.0	PF 6.0
14.0 mm	4.0 mm	3.03.700	3.03.708	3.03.701	3.03.702	3.03.703
16.0 mm	6.0 mm	3.03.704	3.03.709	3.03.705	3.03.706	3.03.707

VARIOfulti analog, stainless steel



Ø	Height	Part Number
4.8 mm	21.2 mm	3.03.800

VARIOfulti analog, for CAD/CAM, titanium



Ø	Length	Part Number
4.8 mm	13.2 mm	3.03.083

VARIOfulti analogs for CAD/CAM are used for 3D-printed models.

Insertion device for VARIOfulti analog for CAD/CAM, stainless steel



Length	Part Number
35.8 mm	3.03.157

LOCATOR® analog, 4 per pack, aluminum



Ø	Part Number
4.0 mm (preferably used with PF 3.5, 4.0 and 4.5 mm)	8530
5.0 mm (preferably used with PF 5.0 and 6.0 mm)	8516

Retentive anchor analog, titanium



Length	Part Number
13.0 mm	3.03.033













Thommen Medical retentive anchors have a spherical diameter of 2.25 mm and are compatible with all matrices of this geometry (e.g. Dalbo®-Plus, Tima®, Ecco®, Pro-Snap®, etc.).

Bar analog, titanium



Length	Ø	Part Number
21.5 mm	4.0 mm	3.03.105

Prosthetic overview PF 3.5

Screws	Gingiva former
<p>Occlusal screw</p>  <p>Length 3.5 mm 4.03.507</p>	<p>Applicable for all restorations</p> <p>Gingiva former customizable</p>  <p>Height 7.5 mm 4.03.570</p>
<p>Screw for bar</p>  <p>Length 4.3 mm 4.03.506</p>	<p>Healing cap SE</p>  <p>Height 1.0 mm 4.03.5155</p>
<p>Abutment screw</p>  <p>Length 5.8 mm 4.03.500</p>	<p>Gingiva former</p>  <p>Height 2.0 mm 4.03.5205 3.2 mm 4.03.5305 4.5 mm 4.03.5405 5.7 mm 4.03.5605 7.0 mm 4.03.5505</p>
<p>VARIOmulti fabrication screw</p>  <p>Length Pcs. 19.3 mm 4 3.03.598 Q4</p>	<p>Gingiva former narrow</p>  <p>Height 2.0 mm 4.04.3105 3.2 mm 4.04.3205 4.5 mm 4.04.3305 5.7 mm 4.04.3405 7.0 mm 4.04.3505</p>
<p>Laboratory screw</p>  <p>Length 25.0 mm 3.03.515</p>	<p>Gingiva former +</p>  <p>Height 2.0 mm 4.03.5255 3.2 mm 4.03.5355</p>
<p>Fabrication screw</p>  <p>Length Pcs. 22.5 mm 4 3.03.590 Q4</p>	
<p>Dynamic Abutment screw</p>  <p>Length 6.6 mm 41.314.069.01-2</p>	

Impression taking

EASY impression coping



	Height	Cone	
EASY	9.5 mm	4.0 mm	2.03.700
EASY	11.5 mm	6.0 mm	2.03.704
ART	11.5 mm	6.0 mm	2.03.705

Temp. restoration

EASY temporary cap



	Height	Cone	
EASY	5.0 mm	4.0 mm	2.03.740
EASY	7.0 mm	6.0 mm	2.03.744
ART	7.0 mm	6.0 mm	2.03.745

Impression copings

Closed tray Open tray Screws

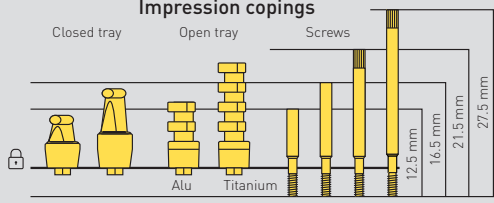

	Conical	Conical	Parallel	
Titanium	3.04.030	3.04.046	3.04.020	
Alu	3.03.074	3.03.014	3.03.010	
				3.03.572
				3.03.573
				3.03.574
				3.03.580

Scan abutment Screw for impression coping

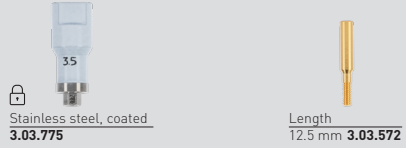

Stainless steel, coated **3.03.775** Length 12.5 mm **3.03.572**

VARIOtemp set



Fabrication screw included

Height
12.0 mm **1.04.080**
12.0 mm **1.04.085***

Impression copings

Closed tray Open tray Screws

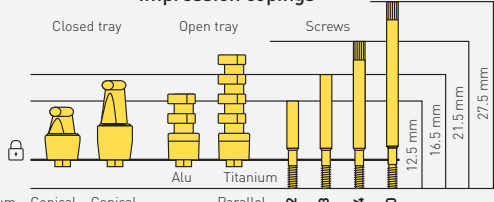

	Conical	Conical	Parallel	
Titanium	3.04.030	3.04.046	3.04.020	
Alu	3.03.074	3.03.014	3.03.010	
				3.03.572
				3.03.573
				3.03.574
				3.03.580

VARIOtemp set



Fabrication screw included

Height
12.0 mm **1.04.080**
12.0 mm **1.04.085***

VARIOmulti impression coping

Open tray Screws

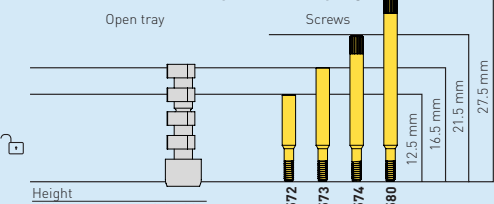

Height 18.0 mm **3.04.805**

3.03.572 **3.03.573** **3.03.574** **3.03.580**

VARIOmulti Scan abutment **VARIOmulti Scan abutment, short**

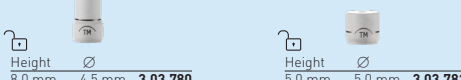

Height 8.0 mm \varnothing 4.5 mm **3.03.780** Height 5.0 mm \varnothing 5.0 mm **3.03.781**

VARIOmulti protective cap **VARIOmulti temp. cap**

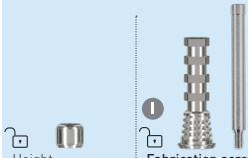

Height 4.5 mm **4.03.801**

Fabrication screw included

Height 15.0 mm **3.03.804**

LOCATOR® Abutment impression coping **Bar abutment Impression coping**



Alu 4 pcs. **8505** Height \varnothing 5.0 mm 6.0 mm **3.03.101**

LOCATOR®













20 pcs. **8515-20**





NOTICE:





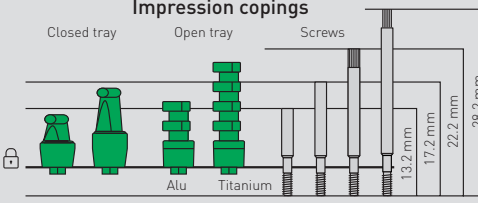
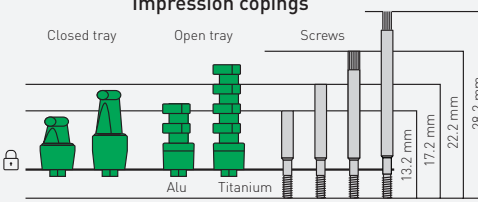

- For information on customized CAD/CAM solutions, visit: www.thommenmedical.com.
- In each case, the symbols correspond to required components, which can be ordered separately **I - VII**.
- **Rotation locked** **Rotation unlocked**
- x.xx.xxx Sterile packed **STERILE**

<h3>Final restoration</h3> <div style="display: flex; justify-content: space-between;"> <div style="width: 48%;"> <h4>EASY abutment</h4> <table border="1"> <thead> <tr> <th>Collar</th> <th>Cone</th> <th>Height</th> <th></th> </tr> </thead> <tbody> <tr> <td>short 0.5 mm</td> <td>4.0 mm</td> <td>4.5 mm</td> <td>4.03.700</td> </tr> <tr> <td>short 0.5 mm</td> <td>6.0 mm</td> <td>6.5 mm</td> <td>4.03.704</td> </tr> <tr> <td>long 2.0 mm</td> <td>4.0 mm</td> <td>6.0 mm</td> <td>4.03.710</td> </tr> <tr> <td>long 2.0 mm</td> <td>6.0 mm</td> <td>8.0 mm</td> <td>4.03.714</td> </tr> <tr> <td>extra long 4.0 mm</td> <td>6.0 mm</td> <td>10.0 mm</td> <td>4.03.734</td> </tr> </tbody> </table> </div> <div style="width: 48%;"> <h4>EASY abutment 20°</h4> <table border="1"> <thead> <tr> <th>Collar</th> <th>Height</th> <th></th> </tr> </thead> <tbody> <tr> <td>20° short 0.5 mm</td> <td>6.5 mm</td> <td>4.03.010</td> </tr> <tr> <td>20° long 3.0 mm</td> <td>8.0 mm</td> <td>4.03.014</td> </tr> </tbody> </table> </div> </div>		Collar	Cone	Height		short 0.5 mm	4.0 mm	4.5 mm	4.03.700	short 0.5 mm	6.0 mm	6.5 mm	4.03.704	long 2.0 mm	4.0 mm	6.0 mm	4.03.710	long 2.0 mm	6.0 mm	8.0 mm	4.03.714	extra long 4.0 mm	6.0 mm	10.0 mm	4.03.734	Collar	Height		20° short 0.5 mm	6.5 mm	4.03.010	20° long 3.0 mm	8.0 mm	4.03.014	<h3>Burn-out cap</h3> <h4>EASY burn-out cap</h4> <table border="1"> <thead> <tr> <th>Height</th> <th>Cone</th> <th></th> </tr> </thead> <tbody> <tr> <td>4.7 mm</td> <td>4.0 mm</td> <td>2.03.720</td> </tr> <tr> <td>6.7 mm</td> <td>6.0 mm</td> <td>2.03.724</td> </tr> <tr> <td>4.7 mm</td> <td>4.0 mm</td> <td>2.03.730*</td> </tr> <tr> <td>6.7 mm</td> <td>6.0 mm</td> <td>2.03.734*</td> </tr> </tbody> </table>		Height	Cone		4.7 mm	4.0 mm	2.03.720	6.7 mm	6.0 mm	2.03.724	4.7 mm	4.0 mm	2.03.730*	6.7 mm	6.0 mm	2.03.734*	<h3>Analog</h3> <div style="display: flex; justify-content: space-between;"> <div style="width: 48%;"> <h4>EASY analog</h4> <table border="1"> <thead> <tr> <th>Cone</th> <th></th> </tr> </thead> <tbody> <tr> <td>4.0 mm</td> <td>3.03.700</td> </tr> <tr> <td>6.0 mm</td> <td>3.03.704</td> </tr> </tbody> </table> </div> <div style="width: 48%;"> <h4>Implant analog</h4> <table border="1"> <thead> <tr> <th>Length</th> <th></th> </tr> </thead> <tbody> <tr> <td>22.0 mm</td> <td>3.03.060</td> </tr> <tr> <td>14.0 mm</td> <td>3.03.090</td> </tr> </tbody> </table> </div> </div>		Cone		4.0 mm	3.03.700	6.0 mm	3.03.704	Length		22.0 mm	3.03.060	14.0 mm	3.03.090
Collar	Cone	Height																																																															
short 0.5 mm	4.0 mm	4.5 mm	4.03.700																																																														
short 0.5 mm	6.0 mm	6.5 mm	4.03.704																																																														
long 2.0 mm	4.0 mm	6.0 mm	4.03.710																																																														
long 2.0 mm	6.0 mm	8.0 mm	4.03.714																																																														
extra long 4.0 mm	6.0 mm	10.0 mm	4.03.734																																																														
Collar	Height																																																																
20° short 0.5 mm	6.5 mm	4.03.010																																																															
20° long 3.0 mm	8.0 mm	4.03.014																																																															
Height	Cone																																																																
4.7 mm	4.0 mm	2.03.720																																																															
6.7 mm	6.0 mm	2.03.724																																																															
4.7 mm	4.0 mm	2.03.730*																																																															
6.7 mm	6.0 mm	2.03.734*																																																															
Cone																																																																	
4.0 mm	3.03.700																																																																
6.0 mm	3.03.704																																																																
Length																																																																	
22.0 mm	3.03.060																																																																
14.0 mm	3.03.090																																																																
<h4>EASY abutment set</h4> <table border="1"> <thead> <tr> <th>Collar</th> <th>Cone</th> <th>Height</th> <th></th> </tr> </thead> <tbody> <tr> <td>short 0.5 mm</td> <td>4.0 mm</td> <td>4.5 mm</td> <td>1.04.700</td> </tr> <tr> <td>short 0.5 mm</td> <td>6.0 mm</td> <td>6.5 mm</td> <td>1.04.704</td> </tr> <tr> <td>long 2.0 mm</td> <td>4.0 mm</td> <td>6.0 mm</td> <td>1.04.710</td> </tr> <tr> <td>long 2.0 mm</td> <td>6.0 mm</td> <td>8.0 mm</td> <td>1.04.714</td> </tr> <tr> <td>extra long 4.0 mm</td> <td>6.0 mm</td> <td>10.0 mm</td> <td>1.04.734</td> </tr> </tbody> </table> <p>Set contents:</p> <ul style="list-style-type: none"> · EASY abutment · abutment screw · EASY impression coping · EASY analog · EASY temporary cap · EASY burn-out cap, for crown, burn-out plastic · EASY burn-out cap, for bridge, burn-out plastic 		Collar	Cone	Height		short 0.5 mm	4.0 mm	4.5 mm	1.04.700	short 0.5 mm	6.0 mm	6.5 mm	1.04.704	long 2.0 mm	4.0 mm	6.0 mm	1.04.710	long 2.0 mm	6.0 mm	8.0 mm	1.04.714	extra long 4.0 mm	6.0 mm	10.0 mm	1.04.734	<h4>Implant analog for CAD/CAM</h4> <table border="1"> <thead> <tr> <th>Length</th> <th></th> </tr> </thead> <tbody> <tr> <td>11.4 mm</td> <td>3.03.085</td> </tr> </tbody> </table>		Length		11.4 mm	3.03.085																																		
Collar	Cone	Height																																																															
short 0.5 mm	4.0 mm	4.5 mm	1.04.700																																																														
short 0.5 mm	6.0 mm	6.5 mm	1.04.704																																																														
long 2.0 mm	4.0 mm	6.0 mm	1.04.710																																																														
long 2.0 mm	6.0 mm	8.0 mm	1.04.714																																																														
extra long 4.0 mm	6.0 mm	10.0 mm	1.04.734																																																														
Length																																																																	
11.4 mm	3.03.085																																																																
<h3>ART abutment set</h3> <h4>ART grinding cylinder set</h4> <table border="1"> <thead> <tr> <th>Abutment screw included</th> <th>Cone</th> <th>Height</th> <th></th> </tr> </thead> <tbody> <tr> <td>6.0 mm</td> <td>9.0 mm</td> <td></td> <td>1.03.623</td> </tr> </tbody> </table>		Abutment screw included	Cone	Height		6.0 mm	9.0 mm		1.03.623	<h3>Dynamic Tibase®</h3> <h4>Dynamic Tibase® customizable length</h4> <table border="1"> <thead> <tr> <th>Abutment screw included</th> <th>Height</th> <th></th> </tr> </thead> <tbody> <tr> <td>4.0 mm</td> <td>31.311.113.01-2</td> <td></td> </tr> <tr> <td>4.0 mm</td> <td>31.321.113.01-2*</td> <td></td> </tr> </tbody> </table>		Abutment screw included	Height		4.0 mm	31.311.113.01-2		4.0 mm	31.321.113.01-2*		<h3>EASY burn-out cap</h3> <table border="1"> <thead> <tr> <th>ART</th> <th>Height</th> <th>Cone</th> <th></th> </tr> </thead> <tbody> <tr> <td>ART</td> <td>6.7 mm</td> <td>6.0 mm</td> <td>2.03.725*</td> </tr> <tr> <td>ART</td> <td>6.7 mm</td> <td>6.0 mm</td> <td>2.03.735*</td> </tr> </tbody> </table>		ART	Height	Cone		ART	6.7 mm	6.0 mm	2.03.725*	ART	6.7 mm	6.0 mm	2.03.735*																															
Abutment screw included	Cone	Height																																																															
6.0 mm	9.0 mm		1.03.623																																																														
Abutment screw included	Height																																																																
4.0 mm	31.311.113.01-2																																																																
4.0 mm	31.321.113.01-2*																																																																
ART	Height	Cone																																																															
ART	6.7 mm	6.0 mm	2.03.725*																																																														
ART	6.7 mm	6.0 mm	2.03.735*																																																														
<h3>VARIOflex set</h3> <table border="1"> <thead> <tr> <th>Abutment screw, burn-out cap included</th> <th>Height</th> <th></th> </tr> </thead> <tbody> <tr> <td>12.0 mm</td> <td>1.04.830</td> <td></td> </tr> <tr> <td>12.0 mm</td> <td>1.04.835*</td> <td></td> </tr> </tbody> </table>		Abutment screw, burn-out cap included	Height		12.0 mm	1.04.830		12.0 mm	1.04.835*		<h3>Titanium Base CAD/CAM set</h3> <table border="1"> <thead> <tr> <th>Abutment screw included</th> <th>Height</th> <th></th> </tr> </thead> <tbody> <tr> <td>5.2 mm</td> <td>1.04.750</td> <td></td> </tr> <tr> <td>5.2 mm</td> <td>1.04.760*</td> <td></td> </tr> </tbody> </table>		Abutment screw included	Height		5.2 mm	1.04.750		5.2 mm	1.04.760*		<h3>Milling abutment for CAD/CAM Type II</h3> <table border="1"> <thead> <tr> <th>Abutment screw included</th> <th>Length</th> <th>∅</th> <th></th> </tr> </thead> <tbody> <tr> <td>15.0 mm</td> <td>8.0 mm</td> <td></td> <td>1.04.401</td> </tr> </tbody> </table>		Abutment screw included	Length	∅		15.0 mm	8.0 mm		1.04.401																																		
Abutment screw, burn-out cap included	Height																																																																
12.0 mm	1.04.830																																																																
12.0 mm	1.04.835*																																																																
Abutment screw included	Height																																																																
5.2 mm	1.04.750																																																																
5.2 mm	1.04.760*																																																																
Abutment screw included	Length	∅																																																															
15.0 mm	8.0 mm		1.04.401																																																														
<h3>VARIOabutment 17° set</h3> <table border="1"> <thead> <tr> <th>∅</th> <th>Height</th> <th>Shoulder height</th> <th>Type</th> <th></th> </tr> </thead> <tbody> <tr> <td>0°</td> <td>5.6 mm</td> <td>0.5 mm</td> <td>A</td> <td>1.03.160</td> </tr> <tr> <td>30°</td> <td>5.6 mm</td> <td>0.5 mm</td> <td>B</td> <td>1.03.180</td> </tr> </tbody> </table> <p>Set contents:</p> <ul style="list-style-type: none"> · VARIO abutment 17° (titanium) · VARIO 17° gold-screw seat · occlusal screw · abutment screw 		∅	Height	Shoulder height	Type		0°	5.6 mm	0.5 mm	A	1.03.160	30°	5.6 mm	0.5 mm	B	1.03.180	<h3>VARIO gold abutment, NOA</h3> <table border="1"> <thead> <tr> <th>Height</th> <th>Cone</th> <th></th> </tr> </thead> <tbody> <tr> <td>12.7 mm</td> <td>3.5 mm</td> <td>2.03.410</td> </tr> <tr> <td>12.7 mm</td> <td>3.5 mm</td> <td>2.03.400*</td> </tr> </tbody> </table>		Height	Cone		12.7 mm	3.5 mm	2.03.410	12.7 mm	3.5 mm	2.03.400*	<h3>VARIO 17° gold screw seat</h3> <table border="1"> <thead> <tr> <th>Height</th> <th>∅</th> <th></th> </tr> </thead> <tbody> <tr> <td>11.3 mm</td> <td>2.9 mm</td> <td>2.03.610</td> </tr> </tbody> </table>		Height	∅		11.3 mm	2.9 mm	2.03.610																														
∅	Height	Shoulder height	Type																																																														
0°	5.6 mm	0.5 mm	A	1.03.160																																																													
30°	5.6 mm	0.5 mm	B	1.03.180																																																													
Height	Cone																																																																
12.7 mm	3.5 mm	2.03.410																																																															
12.7 mm	3.5 mm	2.03.400*																																																															
Height	∅																																																																
11.3 mm	2.9 mm	2.03.610																																																															
<h3>VARIOmulti straight</h3> <table border="1"> <thead> <tr> <th>Height</th> <th>Shoulder height</th> <th></th> </tr> </thead> <tbody> <tr> <td>3.0 mm</td> <td>0.8 mm</td> <td>4.03.600</td> </tr> <tr> <td>4.2 mm</td> <td>2.0 mm</td> <td>4.03.605</td> </tr> <tr> <td>5.2 mm</td> <td>3.0 mm</td> <td>4.03.610</td> </tr> </tbody> </table>		Height	Shoulder height		3.0 mm	0.8 mm	4.03.600	4.2 mm	2.0 mm	4.03.605	5.2 mm	3.0 mm	4.03.610	<h3>VARIOmulti angled</h3> <table border="1"> <thead> <tr> <th>Angle</th> <th>Height</th> <th>Shoulder height</th> <th></th> </tr> </thead> <tbody> <tr> <td>17°</td> <td>4.3 mm</td> <td>2.7 mm</td> <td>4.03.680</td> </tr> <tr> <td>30°</td> <td>4.4 mm</td> <td>3.3 mm</td> <td>4.03.685</td> </tr> </tbody> </table>		Angle	Height	Shoulder height		17°	4.3 mm	2.7 mm	4.03.680	30°	4.4 mm	3.3 mm	4.03.685	<h3>VARIOmulti gold cap NOA</h3> <table border="1"> <thead> <tr> <th>Height</th> <th>∅</th> <th></th> </tr> </thead> <tbody> <tr> <td>4.2/13.5 mm</td> <td>4.8 mm</td> <td>2.03.600</td> </tr> </tbody> </table>		Height	∅		4.2/13.5 mm	4.8 mm	2.03.600																														
Height	Shoulder height																																																																
3.0 mm	0.8 mm	4.03.600																																																															
4.2 mm	2.0 mm	4.03.605																																																															
5.2 mm	3.0 mm	4.03.610																																																															
Angle	Height	Shoulder height																																																															
17°	4.3 mm	2.7 mm	4.03.680																																																														
30°	4.4 mm	3.3 mm	4.03.685																																																														
Height	∅																																																																
4.2/13.5 mm	4.8 mm	2.03.600																																																															
<h3>VARIOmulti titanium base for CAD/CAM</h3> <table border="1"> <thead> <tr> <th>incl. occlusal screw</th> <th>Height</th> <th>∅</th> <th></th> </tr> </thead> <tbody> <tr> <td>4.5 mm</td> <td>4.8 mm</td> <td></td> <td>1.04.850</td> </tr> </tbody> </table>		incl. occlusal screw	Height	∅		4.5 mm	4.8 mm		1.04.850	<h3>VARIOmulti titanium base for CAD/CAM, customizable length</h3> <table border="1"> <thead> <tr> <th>incl. occlusal screw</th> <th>Height</th> <th>∅</th> <th></th> </tr> </thead> <tbody> <tr> <td>9.0 mm</td> <td>4.8 mm</td> <td></td> <td>1.04.851</td> </tr> </tbody> </table>		incl. occlusal screw	Height	∅		9.0 mm	4.8 mm		1.04.851	<h3>VARIOmulti burn-out cap</h3> <table border="1"> <thead> <tr> <th>Height</th> <th>∅</th> <th>pcs.</th> <th></th> </tr> </thead> <tbody> <tr> <td>13.5 mm</td> <td>4.8 mm</td> <td>2</td> <td>2.03.601 02</td> </tr> </tbody> </table>		Height	∅	pcs.		13.5 mm	4.8 mm	2	2.03.601 02																																				
incl. occlusal screw	Height	∅																																																															
4.5 mm	4.8 mm		1.04.850																																																														
incl. occlusal screw	Height	∅																																																															
9.0 mm	4.8 mm		1.04.851																																																														
Height	∅	pcs.																																																															
13.5 mm	4.8 mm	2	2.03.601 02																																																														
<h3>LOCATOR® abutment</h3> <table border="1"> <thead> <tr> <th>Height</th> <th></th> </tr> </thead> <tbody> <tr> <td>0.73 mm</td> <td>8875</td> </tr> <tr> <td>2.0 mm</td> <td>8876</td> </tr> <tr> <td>3.0 mm</td> <td>8877</td> </tr> <tr> <td>4.0 mm</td> <td>8878</td> </tr> <tr> <td>5.0 mm</td> <td>8879*</td> </tr> <tr> <td>6.0 mm</td> <td>8880*</td> </tr> </tbody> </table> <p>*Only available in the US.</p>		Height		0.73 mm	8875	2.0 mm	8876	3.0 mm	8877	4.0 mm	8878	5.0 mm	8879*	6.0 mm	8880*	<h3>RETAIN Milling abutment</h3> <table border="1"> <thead> <tr> <th>Height</th> <th></th> </tr> </thead> <tbody> <tr> <td>11.0 mm</td> <td>4.03.420</td> </tr> </tbody> </table>		Height		11.0 mm	4.03.420	<h3>LOCATOR® analog</h3> <table border="1"> <thead> <tr> <th>Length</th> <th>∅</th> <th>pcs.</th> <th></th> </tr> </thead> <tbody> <tr> <td>4.0 mm</td> <td>4</td> <td>8530</td> </tr> <tr> <td>5.0 mm</td> <td>4</td> <td>8516</td> </tr> </tbody> </table>		Length	∅	pcs.		4.0 mm	4	8530	5.0 mm	4	8516																																
Height																																																																	
0.73 mm	8875																																																																
2.0 mm	8876																																																																
3.0 mm	8877																																																																
4.0 mm	8878																																																																
5.0 mm	8879*																																																																
6.0 mm	8880*																																																																
Height																																																																	
11.0 mm	4.03.420																																																																
Length	∅	pcs.																																																															
4.0 mm	4	8530																																																															
5.0 mm	4	8516																																																															
<h3>VARIOmulti analog</h3> <table border="1"> <thead> <tr> <th>Height</th> <th>∅</th> <th></th> </tr> </thead> <tbody> <tr> <td>21.2 mm</td> <td>4.8 mm</td> <td>3.03.800</td> </tr> </tbody> </table>		Height	∅		21.2 mm	4.8 mm	3.03.800	<h3>VARIOmulti analog for CAD/CAM</h3> <table border="1"> <thead> <tr> <th>Height</th> <th>∅</th> <th></th> </tr> </thead> <tbody> <tr> <td>13.2 mm</td> <td>4.8 mm</td> <td>3.03.083</td> </tr> </tbody> </table>		Height	∅		13.2 mm	4.8 mm	3.03.083	<h3>Bar analog</h3> <table border="1"> <thead> <tr> <th>Length</th> <th></th> </tr> </thead> <tbody> <tr> <td>21.5 mm</td> <td>3.03.105</td> </tr> </tbody> </table>		Length		21.5 mm	3.03.105																																												
Height	∅																																																																
21.2 mm	4.8 mm	3.03.800																																																															
Height	∅																																																																
13.2 mm	4.8 mm	3.03.083																																																															
Length																																																																	
21.5 mm	3.03.105																																																																
<h3>LOCATOR® abutment</h3> <table border="1"> <thead> <tr> <th>Height</th> <th></th> </tr> </thead> <tbody> <tr> <td>0.73 mm</td> <td>8875</td> </tr> <tr> <td>2.0 mm</td> <td>8876</td> </tr> <tr> <td>3.0 mm</td> <td>8877</td> </tr> <tr> <td>4.0 mm</td> <td>8878</td> </tr> <tr> <td>5.0 mm</td> <td>8879*</td> </tr> <tr> <td>6.0 mm</td> <td>8880*</td> </tr> </tbody> </table> <p>*Only available in the US.</p>		Height		0.73 mm	8875	2.0 mm	8876	3.0 mm	8877	4.0 mm	8878	5.0 mm	8879*	6.0 mm	8880*	<h3>RETAIN Bar abutment</h3> <table border="1"> <thead> <tr> <th>Height</th> <th></th> </tr> </thead> <tbody> <tr> <td>5.5 mm</td> <td>4.03.380</td> </tr> </tbody> </table>		Height		5.5 mm	4.03.380	<h3>LOCATOR® analog</h3> <table border="1"> <thead> <tr> <th>Length</th> <th>∅</th> <th>pcs.</th> <th></th> </tr> </thead> <tbody> <tr> <td>4.0 mm</td> <td>4</td> <td>8530</td> </tr> <tr> <td>5.0 mm</td> <td>4</td> <td>8516</td> </tr> </tbody> </table>		Length	∅	pcs.		4.0 mm	4	8530	5.0 mm	4	8516																																
Height																																																																	
0.73 mm	8875																																																																
2.0 mm	8876																																																																
3.0 mm	8877																																																																
4.0 mm	8878																																																																
5.0 mm	8879*																																																																
6.0 mm	8880*																																																																
Height																																																																	
5.5 mm	4.03.380																																																																
Length	∅	pcs.																																																															
4.0 mm	4	8530																																																															
5.0 mm	4	8516																																																															
<h3>LOCATOR® abutment</h3> <table border="1"> <thead> <tr> <th>Height</th> <th></th> </tr> </thead> <tbody> <tr> <td>0.73 mm</td> <td>8875</td> </tr> <tr> <td>2.0 mm</td> <td>8876</td> </tr> <tr> <td>3.0 mm</td> <td>8877</td> </tr> <tr> <td>4.0 mm</td> <td>8878</td> </tr> <tr> <td>5.0 mm</td> <td>8879*</td> </tr> <tr> <td>6.0 mm</td> <td>8880*</td> </tr> </tbody> </table> <p>*Only available in the US.</p>		Height		0.73 mm	8875	2.0 mm	8876	3.0 mm	8877	4.0 mm	8878	5.0 mm	8879*	6.0 mm	8880*	<h3>RETAIN Coping for bar</h3> <table border="1"> <thead> <tr> <th>Material</th> <th></th> </tr> </thead> <tbody> <tr> <td>Gold</td> <td>2.03.335</td> </tr> <tr> <td>Titanium</td> <td>4.03.070</td> </tr> </tbody> </table>		Material		Gold	2.03.335	Titanium	4.03.070	<h3>LOCATOR® analog</h3> <table border="1"> <thead> <tr> <th>Length</th> <th>∅</th> <th>pcs.</th> <th></th> </tr> </thead> <tbody> <tr> <td>4.0 mm</td> <td>4</td> <td>8530</td> </tr> <tr> <td>5.0 mm</td> <td>4</td> <td>8516</td> </tr> </tbody> </table>		Length	∅	pcs.		4.0 mm	4	8530	5.0 mm	4	8516																														
Height																																																																	
0.73 mm	8875																																																																
2.0 mm	8876																																																																
3.0 mm	8877																																																																
4.0 mm	8878																																																																
5.0 mm	8879*																																																																
6.0 mm	8880*																																																																
Material																																																																	
Gold	2.03.335																																																																
Titanium	4.03.070																																																																
Length	∅	pcs.																																																															
4.0 mm	4	8530																																																															
5.0 mm	4	8516																																																															

Prosthetic overview PF 4.0

Screws	Gingiva former
<p>Occlusal screw</p>  <p>Length 3.5 mm 4.03.507</p>	<p>Applicable for all restorations</p> <p>Gingiva former customizable</p>  <p>Height 7.5 mm 4.03.571</p>
<p>Screw for bar</p>  <p>Length 4.3 mm 4.03.506</p>	<p>Healing cap SE</p>  <p>Height 1.0 mm 4.03.5195</p>
<p>Abutment screw</p>  <p>Length 7.2 mm 4.03.501 10.2 mm 4.03.502</p>	<p>Gingiva former</p>  <p>Height 2.0 mm 4.03.5245 3.2 mm 4.03.5345 4.5 mm 4.03.5445 5.7 mm 4.03.5645 7.0 mm 4.03.5545</p>
<p>VARIOmulti fabrication screw</p>  <p>Length Pcs. 19.3 mm 4 3.03.598 04</p>	<p>Gingiva former narrow</p>  <p>Height 2.0 mm 4.04.3115 3.2 mm 4.04.3215 4.5 mm 4.04.3315 5.7 mm 4.04.3415 7.0 mm 4.04.3515</p>
<p>Laboratory screw</p>  <p>Length 25.0 mm 3.03.516</p>	
<p>Fabrication screw</p>  <p>Length Pcs. 23.4 mm 4 3.03.591 04</p>	
<p>Dynamic Abutment screw</p>  <p>Length 7.2 mm 41.316.076.02-2</p>	

	Impression taking																				
Cemented	<p>EASY impression coping</p>  <table border="1"> <thead> <tr> <th></th> <th>Height</th> <th>Cone</th> <th></th> </tr> </thead> <tbody> <tr> <td>EASY</td> <td>9.5 mm</td> <td>4.0 mm</td> <td>2.03.708</td> </tr> <tr> <td>EASY</td> <td>11.5 mm</td> <td>6.0 mm</td> <td>2.03.709</td> </tr> <tr> <td>EASY e.p.</td> <td>9.5 mm</td> <td>4.0 mm</td> <td>2.03.701</td> </tr> <tr> <td>EASY e.p./ART</td> <td>11.5 mm</td> <td>6.0 mm</td> <td>2.03.705</td> </tr> </tbody> </table>		Height	Cone		EASY	9.5 mm	4.0 mm	2.03.708	EASY	11.5 mm	6.0 mm	2.03.709	EASY e.p.	9.5 mm	4.0 mm	2.03.701	EASY e.p./ART	11.5 mm	6.0 mm	2.03.705
		Height	Cone																		
EASY	9.5 mm	4.0 mm	2.03.708																		
EASY	11.5 mm	6.0 mm	2.03.709																		
EASY e.p.	9.5 mm	4.0 mm	2.03.701																		
EASY e.p./ART	11.5 mm	6.0 mm	2.03.705																		
Screw-retained & cemented	<p>Impression copings</p>  <table border="1"> <thead> <tr> <th></th> <th>Conical</th> <th>Conical</th> <th>Conical</th> <th>Conical</th> <th></th> </tr> </thead> <tbody> <tr> <td>Titanium</td> <td>3.04.031</td> <td>3.04.047</td> <td>3.03.078</td> <td>3.04.037</td> <td></td> </tr> <tr> <td>Alu</td> <td>3.03.079</td> <td>3.03.019</td> <td>3.03.018</td> <td>3.04.021</td> <td></td> </tr> </tbody> </table> <p>Scan abutment: 3.03.776 (Stainless steel, coated)</p> <p>Screw for impression coping: 3.03.575 (Length 13.2 mm)</p>		Conical	Conical	Conical	Conical		Titanium	3.04.031	3.04.047	3.03.078	3.04.037		Alu	3.03.079	3.03.019	3.03.018	3.04.021			
		Conical	Conical	Conical	Conical																
Titanium	3.04.031	3.04.047	3.03.078	3.04.037																	
Alu	3.03.079	3.03.019	3.03.018	3.04.021																	
Screw-retained	<p>Impression copings</p>  <table border="1"> <thead> <tr> <th></th> <th>Conical</th> <th>Conical</th> <th>Conical</th> <th>Conical</th> <th></th> </tr> </thead> <tbody> <tr> <td>Titanium</td> <td>3.04.031</td> <td>3.04.047</td> <td>3.03.078</td> <td>3.04.037</td> <td></td> </tr> <tr> <td>Alu</td> <td>3.03.079</td> <td>3.03.019</td> <td>3.03.018</td> <td>3.04.021</td> <td></td> </tr> </tbody> </table> <p>VARIOmulti impression coping: 3.04.805 (Height 18.0 mm)</p> <p>VARIOmulti impression coping: 3.03.572, 3.03.573, 3.03.574, 3.03.580</p>		Conical	Conical	Conical	Conical		Titanium	3.04.031	3.04.047	3.03.078	3.04.037		Alu	3.03.079	3.03.019	3.03.018	3.04.021			
		Conical	Conical	Conical	Conical																
Titanium	3.04.031	3.04.047	3.03.078	3.04.037																	
Alu	3.03.079	3.03.019	3.03.018	3.04.021																	
Overdenture	<p>VARIOmulti Scan abutment</p>  <p>Height 8.0 mm, Ø 4.5 mm 3.03.780</p> <p>VARIOmulti Scan abutment, short</p>  <p>Height 5.0 mm, Ø 5.0 mm 3.03.781</p> <p>LOCATOR® Abutment impression coping</p>  <p>Alu 4 pcs. 8505</p> <p>Bar abutment Impression coping</p>  <p>Height Ø 5.0 mm 6.0 mm 3.03.101</p>																				

Temp. restoration																				
<p>EASY temporary cap</p>  <table border="1"> <thead> <tr> <th></th> <th>Height</th> <th>Cone</th> <th></th> </tr> </thead> <tbody> <tr> <td>EASY</td> <td>5.0 mm</td> <td>4.0 mm</td> <td>2.03.748</td> </tr> <tr> <td>EASY</td> <td>7.0 mm</td> <td>6.0 mm</td> <td>2.03.749</td> </tr> <tr> <td>EASY e.p.</td> <td>5.0 mm</td> <td>4.0 mm</td> <td>2.03.741</td> </tr> <tr> <td>EASY e.p./ART</td> <td>7.0 mm</td> <td>6.0 mm</td> <td>2.03.745</td> </tr> </tbody> </table>		Height	Cone		EASY	5.0 mm	4.0 mm	2.03.748	EASY	7.0 mm	6.0 mm	2.03.749	EASY e.p.	5.0 mm	4.0 mm	2.03.741	EASY e.p./ART	7.0 mm	6.0 mm	2.03.745
	Height	Cone																		
EASY	5.0 mm	4.0 mm	2.03.748																	
EASY	7.0 mm	6.0 mm	2.03.749																	
EASY e.p.	5.0 mm	4.0 mm	2.03.741																	
EASY e.p./ART	7.0 mm	6.0 mm	2.03.745																	
<p>VARIOtemp set</p>  <p>Fabrication screw included</p> <p>Height 12.0 mm 1.04.081 12.0 mm 1.04.086*</p>																				
<p>VARIOtemp set</p>  <p>Fabrication screw included</p> <p>Height 12.0 mm 1.04.081 12.0 mm 1.04.086*</p>																				
<p>VARIOmulti protective cap</p>  <p>Height 4.5 mm 4.03.801</p> <p>VARIOmulti temp. cap</p>  <p>Fabrication screw included</p> <p>Height 15.0 mm 3.03.804</p>																				
<p>LOCATOR®</p>  <p>20 pcs. 8515-20</p>																				

NOTICE:

- For information on customized CAD/CAM solutions, visit: www.thommenmedical.com.
- In each case, the symbols correspond to required components, which can be ordered separately **I** - **VII**.
- **Rotation locked** **Rotation unlocked**
- x.xx.xxxS Sterile packed **STERILE**

Final restoration

EASY abutment

Collar	Cone	Height	
short 0.5 mm	4.0 mm	4.5 mm	4.03.708
short 0.5 mm	6.0 mm	6.5 mm	4.03.709
long 2.0 mm	4.0 mm	6.0 mm	4.03.718
long 2.0 mm	6.0 mm	8.0 mm	4.03.719
extra long 4.0 mm	6.0 mm	10.0 mm	4.03.739

EASY abutment 20°

Collar	Height	
20° short 0.5 mm	6.5 mm	4.03.018
20° long 3.0 mm	9.0 mm	4.03.019

EASY abutment set

Collar	Cone	Height	
short 0.5 mm	4.0 mm	4.5 mm	1.04.708
short 0.5 mm	6.0 mm	6.5 mm	1.04.709
long 2.0 mm	4.0 mm	6.0 mm	1.04.718
long 2.0 mm	6.0 mm	8.0 mm	1.04.719
extra long 4.0 mm	6.0 mm	10.0 mm	1.04.739

Set contents:

- EASY abutment
- abutment screw
- EASY impression coping
- EASY analog
- EASY temporary cap
- EASY burn-out cap for crown
- EASY burn-out cap for bridge

EASY abutment e.p.

Height	Cone	
7.0 mm	4.0 mm	4.03.728
9.0 mm	6.0 mm	4.03.729

Burn-out cap

EASY burn-out cap

Height	Cone	
EASY 4.7 mm	4.0 mm	2.03.728
EASY 6.7 mm	6.0 mm	2.03.729
EASY 4.7 mm	4.0 mm	2.03.738*
EASY 6.7 mm	6.0 mm	2.03.739*
EASY e.p. 4.7 mm	4.0 mm	2.03.721
EASY e.p. 6.7 mm	6.0 mm	2.03.725
EASY e.p. 4.7 mm	4.0 mm	2.03.731*
EASY e.p. 6.7 mm	6.0 mm	2.03.735*

Analog

EASY analog

Cone	
EASY 4.0 mm	3.03.708
EASY 6.0 mm	3.03.709
EASY e.p. 4.0 mm	3.03.701
EASY e.p. 6.0 mm	3.03.705

Implant analog

Length	
22.0 mm	3.03.061
14.0 mm	3.03.095

Implant analog for CAD/CAM

Length	
11.4 mm	3.03.086

ART abutment set

Abutment screw included	Cone	Height	
6.0 mm	9.0 mm		1.03.624

ART grinding cylinder set

Abutment screw included	Height	
12.0 mm		1.03.650

Dynamic Tibase®

Abutment screw included	Height	
4.0 mm		31.312.114.01-2
4.0 mm		31.322.114.01-2*

Dynamic Tibase® customizable length

Abutment screw included	Height	
9.0 mm		31.312.114.21-2
9.0 mm		31.322.114.21-2*

Burn-out cap

EASY burn-out cap

Height	Cone	
ART 6.7 mm	6.0 mm	2.03.725
ART 6.7 mm	6.0 mm	2.03.735*

Analog

EASY analog

Cone	
ART 6.0 mm	3.03.705

Implant analog

Length	
22.0 mm	3.03.061
14.0 mm	3.03.095

VARIOflex set

Abutment screw, burn-out cap included	Height	
12.0 mm		1.04.831
12.0 mm		1.04.836*

Titanium Base CAD/CAM set

Abutment screw included	Height	
5.2 mm		1.04.751
5.2 mm		1.04.761*

Milling abutment for CAD/CAM Type II

Abutment screw included	Length	∅	
15.0 mm	11.5 mm		1.04.403

VARIOeco burn-out cap

Height	
12.0 mm	2.03.791

VARIOflex burn-out cap

Height	
11.5 mm	2.03.841

Implant analog for CAD/CAM

Length	
11.4 mm	3.03.086

VARIO abutment 17° set

∅	Height	Shoulder height	Type	
0°	5.6 mm	0.5 mm	A	1.03.161
30°	5.6 mm	0.5 mm	B	1.03.181

Set contents:

- VARIO abutment 17° (titanium)
- VARIO 17° gold screw seat
- occlusal screw
- abutment screw

VARIO gold abutment, NOA

Height	Cone	
12.7 mm	3.5 mm	2.03.414
12.7 mm	3.5 mm	2.03.404*

VARIO 17° gold screw seat

Height	∅	
11.3 mm	2.9 mm	2.03.610

Implant analog for CAD/CAM

Length	
11.4 mm	3.03.086

Implant analog

Length	
22.0 mm	3.03.061
14.0 mm	3.03.095

VARIOmulti straight

Height	Shoulder height	
3.0 mm	0.8 mm	4.03.601
4.2 mm	2.0 mm	4.03.606
5.2 mm	3.0 mm	4.03.611

VARIOmulti angled

Angle	Height	Shoulder height	
17°	4.3 mm	2.7 mm	4.03.681
30°	4.4 mm	3.3 mm	4.03.686

VARIOmulti gold cap, NOA

Height	∅	
4.2/13.5 mm	4.8 mm	2.03.600

VARIOmulti burn-out cap

Height	∅	pcs.	
13.5 mm	4.8 mm	2	2.03.601 Q2

VARIOmulti analog

Height	∅	
21.2 mm	4.8 mm	3.03.800

VARIOmulti analog for CAD/CAM

Height	∅	
13.2 mm	4.8 mm	3.03.083

VARIOmulti titanium base for CAD/CAM

Height	∅	
4.5 mm	4.8 mm	1.04.850

VARIOmulti titanium base for CAD/CAM, customizable length

Height	∅	
9.0 mm	4.8 mm	1.04.851

LOCATOR® For components, see: thommenmedical.com or product catalogue

Retentive anchor Analog

Length	
13.0 mm	3.03.033

LOCATOR® analog

∅	Pcs.	
4.0 mm	4	8530
5.0 mm	4	8516

LOCATOR® abutment

Height	
1.0 mm	8461
2.0 mm	8462
3.0 mm	8463
4.0 mm	8464
5.0 mm	8465
6.0 mm	8466

Retentive anchor abutment

Height	
1.8 mm	4.03.048
3.0 mm	4.03.049

RETAIN Milling abutment

Height	
12.0 mm	4.03.428

Bar abutment











Height	
5.5 mm	4.03.388









Coping for bar

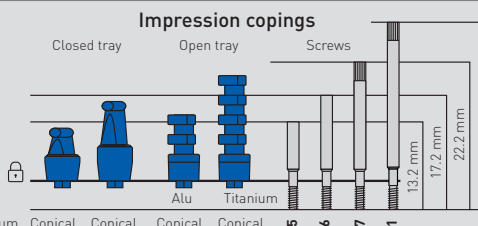

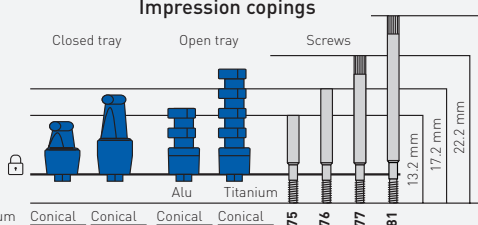

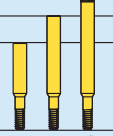

Gold	
	2.03.335
Titanium	4.03.070

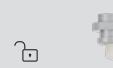
LOCATOR® For components, see: thommenmedical.com or product catalogue

Prosthetic overview PF 4.5

Screws	Gingiva former
<p>Occlusal screw</p>  <p>Length 3.5 mm 4.03.507</p>	<p>Applicable for all restorations</p> <p>Gingiva former customizable</p>  <p>Height 7.5 mm 4.03.572</p>
<p>Screw for bar</p>  <p>Length 4.3 mm 4.03.506</p>	<p>Healing cap SE</p>  <p>Height 1.0 mm 4.03.5165</p>
<p>Abutment screw</p>  <p>Length 7.2 mm 4.03.501 10.2 mm 4.03.502</p>	<p>Gingiva former</p>  <p>Height 2.0 mm 4.03.5215 3.2 mm 4.03.5315 4.5 mm 4.03.5415 5.7 mm 4.03.5615 7.0 mm 4.03.5515</p>
<p>VARIOfabrication screw</p>  <p>Length Pcs. 19.3 mm 4 3.03.598 04</p>	<p>Gingiva former narrow</p>  <p>Height 2.0 mm 4.04.3125 3.2 mm 4.04.3225 4.5 mm 4.04.3325 5.7 mm 4.04.3425 7.0 mm 4.04.3525</p>
<p>Laboratory screw</p>  <p>Length 25.0 mm 3.03.516</p>	
<p>Fabrication screw</p>  <p>Length Pcs. 23.4 mm 4 3.03.591 04</p>	
<p>Dynamic Abutment screw</p>  <p>Length 7.2 mm 41.316.076.02-2</p>	

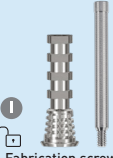
	Impression taking																								
Cemented	<p>EASY impression coping</p>  <table border="1"> <thead> <tr> <th></th> <th>Height</th> <th>Cone</th> <th></th> </tr> </thead> <tbody> <tr> <td>EASY</td> <td>9.5 mm</td> <td>4.0 mm</td> <td>2.03.701</td> </tr> <tr> <td>EASY</td> <td>11.5 mm</td> <td>6.0 mm</td> <td>2.03.705</td> </tr> <tr> <td>EASY e.p.</td> <td>9.5 mm</td> <td>4.0 mm</td> <td>2.03.702</td> </tr> <tr> <td>EASY e.p./ART</td> <td>11.5 mm</td> <td>6.0 mm</td> <td>2.03.706</td> </tr> </tbody> </table>		Height	Cone		EASY	9.5 mm	4.0 mm	2.03.701	EASY	11.5 mm	6.0 mm	2.03.705	EASY e.p.	9.5 mm	4.0 mm	2.03.702	EASY e.p./ART	11.5 mm	6.0 mm	2.03.706				
		Height	Cone																						
EASY	9.5 mm	4.0 mm	2.03.701																						
EASY	11.5 mm	6.0 mm	2.03.705																						
EASY e.p.	9.5 mm	4.0 mm	2.03.702																						
EASY e.p./ART	11.5 mm	6.0 mm	2.03.706																						
Screw-retained & cemented	<p>Impression copings</p>  <table border="1"> <thead> <tr> <th></th> <th>Alu</th> <th>Titanium</th> </tr> </thead> <tbody> <tr> <td>Titanium</td> <td>Conical 3.04.032</td> <td>Conical 3.04.048</td> </tr> <tr> <td>Alu</td> <td>Conical 3.03.075</td> <td>Conical 3.03.071</td> </tr> <tr> <td></td> <td>Parallel 3.03.011</td> <td>Parallel 3.04.022</td> </tr> <tr> <td></td> <td></td> <td>3.03.575</td> </tr> <tr> <td></td> <td></td> <td>3.03.576</td> </tr> <tr> <td></td> <td></td> <td>3.03.577</td> </tr> <tr> <td></td> <td></td> <td>3.03.581</td> </tr> </tbody> </table>		Alu	Titanium	Titanium	Conical 3.04.032	Conical 3.04.048	Alu	Conical 3.03.075	Conical 3.03.071		Parallel 3.03.011	Parallel 3.04.022			3.03.575			3.03.576			3.03.577			3.03.581
		Alu	Titanium																						
Titanium	Conical 3.04.032	Conical 3.04.048																							
Alu	Conical 3.03.075	Conical 3.03.071																							
	Parallel 3.03.011	Parallel 3.04.022																							
		3.03.575																							
		3.03.576																							
		3.03.577																							
		3.03.581																							
Screw-retained	<p>Scan abutment</p>  <p>Stainless steel, coated 3.03.777</p>																								
	<p>Screw for impression coping</p>  <p>Length 13.2 mm 3.03.575</p>																								
Screw-retained	<p>Impression copings</p>  <table border="1"> <thead> <tr> <th></th> <th>Alu</th> <th>Titanium</th> </tr> </thead> <tbody> <tr> <td>Titanium</td> <td>Conical 3.04.032</td> <td>Conical 3.04.048</td> </tr> <tr> <td>Alu</td> <td>Conical 3.03.075</td> <td>Conical 3.03.071</td> </tr> <tr> <td></td> <td>Parallel 3.03.011</td> <td>Parallel 3.04.022</td> </tr> <tr> <td></td> <td></td> <td>3.03.575</td> </tr> <tr> <td></td> <td></td> <td>3.03.576</td> </tr> <tr> <td></td> <td></td> <td>3.03.577</td> </tr> <tr> <td></td> <td></td> <td>3.03.581</td> </tr> </tbody> </table>		Alu	Titanium	Titanium	Conical 3.04.032	Conical 3.04.048	Alu	Conical 3.03.075	Conical 3.03.071		Parallel 3.03.011	Parallel 3.04.022			3.03.575			3.03.576			3.03.577			3.03.581
		Alu	Titanium																						
Titanium	Conical 3.04.032	Conical 3.04.048																							
Alu	Conical 3.03.075	Conical 3.03.071																							
	Parallel 3.03.011	Parallel 3.04.022																							
		3.03.575																							
		3.03.576																							
		3.03.577																							
		3.03.581																							
Overdenture	<p>VARIOfabrication impression coping</p>  <p>Height 18.0 mm 3.04.805</p>																								
	<p>VARIOfabrication impression coping, short</p>  <p>Height 3.03.572 3.03.573 3.03.574 3.03.580</p>																								
Overdenture	<p>VARIOfabrication Scan abutment</p>  <p>Height 8.0 mm</p> <p>∅ 4.5 mm 3.03.780</p>																								
	<p>VARIOfabrication Scan abutment, short</p>  <p>Height 5.0 mm</p> <p>∅ 5.0 mm 3.03.781</p>																								
Overdenture	<p>LOCATOR® Abutment impression coping</p>  <p>Alu 4 pcs. 8505</p>																								
	<p>Bar abutment Impression coping</p>  <p>Height ∅ 5.0 mm 6.0 mm 3.03.101</p>																								











Temp. restoration																				
<p>EASY temporary cap</p>  <table border="1"> <thead> <tr> <th></th> <th>Height</th> <th>Cone</th> <th></th> </tr> </thead> <tbody> <tr> <td>EASY</td> <td>5.0 mm</td> <td>4.0 mm</td> <td>2.03.741</td> </tr> <tr> <td>EASY</td> <td>7.0 mm</td> <td>6.0 mm</td> <td>2.03.745</td> </tr> <tr> <td>EASY e.p.</td> <td>5.0 mm</td> <td>4.0 mm</td> <td>2.03.742</td> </tr> <tr> <td>EASY e.p./ART</td> <td>7.0 mm</td> <td>6.0 mm</td> <td>2.03.746</td> </tr> </tbody> </table>		Height	Cone		EASY	5.0 mm	4.0 mm	2.03.741	EASY	7.0 mm	6.0 mm	2.03.745	EASY e.p.	5.0 mm	4.0 mm	2.03.742	EASY e.p./ART	7.0 mm	6.0 mm	2.03.746
	Height	Cone																		
EASY	5.0 mm	4.0 mm	2.03.741																	
EASY	7.0 mm	6.0 mm	2.03.745																	
EASY e.p.	5.0 mm	4.0 mm	2.03.742																	
EASY e.p./ART	7.0 mm	6.0 mm	2.03.746																	
<p>VARIOfabrication set</p>  <p>Fabrication screw included</p> <p>Height 12.0 mm 1.04.082 12.0 mm 1.04.087*</p>																				
<p>VARIOfabrication set</p>  <p>Fabrication screw included</p> <p>Height 12.0 mm 1.04.082 12.0 mm 1.04.087*</p>																				
<p>VARIOfabrication protective cap</p>  <p>Height 4.5 mm 4.03.801</p>																				
<p>VARIOfabrication temp. cap</p>  <p>Fabrication screw included</p> <p>Height 15.0 mm 3.03.804</p>																				
<p>LOCATOR®</p>  <p>20 pcs. 8515-20</p>																				



NOTICE:





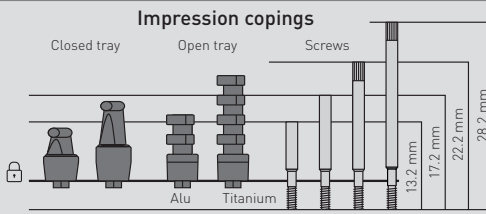
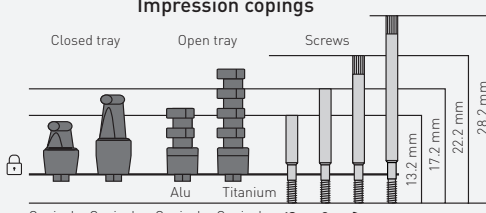
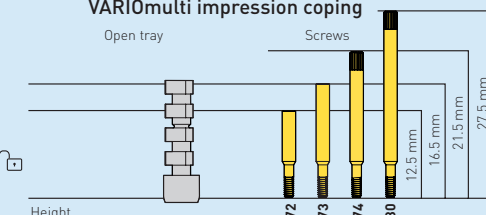

- For information on customized CAD/CAM solutions, visit: www.thommenmedical.com.
- In each case, the symbols correspond to required components, which can be ordered separately **I** - **VII**.
- **Rotation locked** **Rotation unlocked**
- x.xx.xxxS Sterile packed **STERILE**

Final restoration			Burn-out cap		Analog																																																													
EASY abutment <table border="1"> <tr><th>Collar</th><th>Cone</th><th>Height</th></tr> <tr><td>short 0.5 mm</td><td>4.0 mm 4.5 mm</td><td>4.03.701</td></tr> <tr><td>short 0.5 mm</td><td>6.0 mm 6.5 mm</td><td>4.03.705</td></tr> <tr><td>long 2.0 mm</td><td>4.0 mm 6.0 mm</td><td>4.03.711</td></tr> <tr><td>long 2.0 mm</td><td>6.0 mm 8.0 mm</td><td>4.03.715</td></tr> <tr><td>extra long 4.0 mm</td><td>6.0 mm 10.0 mm</td><td>4.03.735</td></tr> </table>			Collar	Cone	Height	short 0.5 mm	4.0 mm 4.5 mm	4.03.701	short 0.5 mm	6.0 mm 6.5 mm	4.03.705	long 2.0 mm	4.0 mm 6.0 mm	4.03.711	long 2.0 mm	6.0 mm 8.0 mm	4.03.715	extra long 4.0 mm	6.0 mm 10.0 mm	4.03.735	EASY abutment 20° <table border="1"> <tr><th>Collar</th><th>Height</th></tr> <tr><td>20° short 0.5 mm</td><td>6.5 mm 4.03.011</td></tr> <tr><td>20° long 3.0 mm</td><td>9.0 mm 4.03.015</td></tr> </table>		Collar	Height	20° short 0.5 mm	6.5 mm 4.03.011	20° long 3.0 mm	9.0 mm 4.03.015	EASY burn-out cap <table border="1"> <tr><th>Height</th><th>Cone</th></tr> <tr><td>EASY 4.7 mm 4.0 mm</td><td>2.03.721</td></tr> <tr><td>EASY 6.7 mm 6.0 mm</td><td>2.03.725</td></tr> <tr><td>EASY 4.7 mm 4.0 mm</td><td>2.03.731*</td></tr> <tr><td>EASY 6.7 mm 6.0 mm</td><td>2.03.735*</td></tr> <tr><td>EASY e.p. 4.7 mm 4.0 mm</td><td>2.03.722</td></tr> <tr><td>EASY e.p. 6.7 mm 6.0 mm</td><td>2.03.726</td></tr> <tr><td>EASY e.p. 4.7 mm 4.0 mm</td><td>2.03.732*</td></tr> <tr><td>EASY e.p. 6.7 mm 6.0 mm</td><td>2.03.736*</td></tr> </table>		Height	Cone	EASY 4.7 mm 4.0 mm	2.03.721	EASY 6.7 mm 6.0 mm	2.03.725	EASY 4.7 mm 4.0 mm	2.03.731*	EASY 6.7 mm 6.0 mm	2.03.735*	EASY e.p. 4.7 mm 4.0 mm	2.03.722	EASY e.p. 6.7 mm 6.0 mm	2.03.726	EASY e.p. 4.7 mm 4.0 mm	2.03.732*	EASY e.p. 6.7 mm 6.0 mm	2.03.736*	EASY analog <table border="1"> <tr><th>Cone</th></tr> <tr><td>EASY 4.0 mm</td><td>3.03.701</td></tr> <tr><td>EASY 6.0 mm</td><td>3.03.705</td></tr> <tr><td>EASY e.p. 4.0 mm</td><td>3.03.702</td></tr> <tr><td>EASY e.p. 6.0 mm</td><td>3.03.706</td></tr> </table>		Cone	EASY 4.0 mm	3.03.701	EASY 6.0 mm	3.03.705	EASY e.p. 4.0 mm	3.03.702	EASY e.p. 6.0 mm	3.03.706	Implant analog <table border="1"> <tr><th>Length</th></tr> <tr><td>22.0 mm</td><td>3.03.065</td></tr> <tr><td>14.0 mm</td><td>3.03.091</td></tr> </table>		Length	22.0 mm	3.03.065	14.0 mm	3.03.091
Collar	Cone	Height																																																																
short 0.5 mm	4.0 mm 4.5 mm	4.03.701																																																																
short 0.5 mm	6.0 mm 6.5 mm	4.03.705																																																																
long 2.0 mm	4.0 mm 6.0 mm	4.03.711																																																																
long 2.0 mm	6.0 mm 8.0 mm	4.03.715																																																																
extra long 4.0 mm	6.0 mm 10.0 mm	4.03.735																																																																
Collar	Height																																																																	
20° short 0.5 mm	6.5 mm 4.03.011																																																																	
20° long 3.0 mm	9.0 mm 4.03.015																																																																	
Height	Cone																																																																	
EASY 4.7 mm 4.0 mm	2.03.721																																																																	
EASY 6.7 mm 6.0 mm	2.03.725																																																																	
EASY 4.7 mm 4.0 mm	2.03.731*																																																																	
EASY 6.7 mm 6.0 mm	2.03.735*																																																																	
EASY e.p. 4.7 mm 4.0 mm	2.03.722																																																																	
EASY e.p. 6.7 mm 6.0 mm	2.03.726																																																																	
EASY e.p. 4.7 mm 4.0 mm	2.03.732*																																																																	
EASY e.p. 6.7 mm 6.0 mm	2.03.736*																																																																	
Cone																																																																		
EASY 4.0 mm	3.03.701																																																																	
EASY 6.0 mm	3.03.705																																																																	
EASY e.p. 4.0 mm	3.03.702																																																																	
EASY e.p. 6.0 mm	3.03.706																																																																	
Length																																																																		
22.0 mm	3.03.065																																																																	
14.0 mm	3.03.091																																																																	
EASY abutment set <table border="1"> <tr><th>Collar</th><th>Cone</th><th>Height</th></tr> <tr><td>short 0.5 mm</td><td>4.0 mm 4.5 mm</td><td>1.04.701</td></tr> <tr><td>short 0.5 mm</td><td>6.0 mm 6.5 mm</td><td>1.04.705</td></tr> <tr><td>long 2.0 mm</td><td>4.0 mm 6.0 mm</td><td>1.04.711</td></tr> <tr><td>long 2.0 mm</td><td>6.0 mm 8.0 mm</td><td>1.04.715</td></tr> <tr><td>extra long 4.0 mm</td><td>6.0 mm 10.0 mm</td><td>1.04.735</td></tr> </table>			Collar	Cone	Height	short 0.5 mm	4.0 mm 4.5 mm	1.04.701	short 0.5 mm	6.0 mm 6.5 mm	1.04.705	long 2.0 mm	4.0 mm 6.0 mm	1.04.711	long 2.0 mm	6.0 mm 8.0 mm	1.04.715	extra long 4.0 mm	6.0 mm 10.0 mm	1.04.735	EASY abutment e.p. <table border="1"> <tr><th>Height</th><th>Cone</th></tr> <tr><td>7.0 mm</td><td>4.0 mm 4.03.721</td></tr> <tr><td>9.0 mm</td><td>6.0 mm 4.03.725</td></tr> </table>		Height	Cone	7.0 mm	4.0 mm 4.03.721	9.0 mm	6.0 mm 4.03.725	Implant analog for CAD/CAM <table border="1"> <tr><th>Length</th></tr> <tr><td>11.4 mm</td><td>3.03.087</td></tr> </table>		Length	11.4 mm	3.03.087																																	
Collar	Cone	Height																																																																
short 0.5 mm	4.0 mm 4.5 mm	1.04.701																																																																
short 0.5 mm	6.0 mm 6.5 mm	1.04.705																																																																
long 2.0 mm	4.0 mm 6.0 mm	1.04.711																																																																
long 2.0 mm	6.0 mm 8.0 mm	1.04.715																																																																
extra long 4.0 mm	6.0 mm 10.0 mm	1.04.735																																																																
Height	Cone																																																																	
7.0 mm	4.0 mm 4.03.721																																																																	
9.0 mm	6.0 mm 4.03.725																																																																	
Length																																																																		
11.4 mm	3.03.087																																																																	
ART abutment set <table border="1"> <tr><th>Abutment screw included</th><th>Cone</th><th>Height</th></tr> <tr><td></td><td>6.0 mm 9.0 mm</td><td>1.03.625</td></tr> </table>			Abutment screw included	Cone	Height		6.0 mm 9.0 mm	1.03.625	ART grinding cylinder set <table border="1"> <tr><th>Abutment screw included</th><th>Height</th></tr> <tr><td></td><td>12.0 mm 1.03.651</td></tr> </table>		Abutment screw included	Height		12.0 mm 1.03.651	Dynamic Tibase® <table border="1"> <tr><th>Abutment screw included</th><th>Height</th></tr> <tr><td></td><td>4.0 mm 31.313.115.01-2</td></tr> <tr><td></td><td>4.0 mm 31.323.115.01-2*</td></tr> </table>		Abutment screw included	Height		4.0 mm 31.313.115.01-2		4.0 mm 31.323.115.01-2*	Dynamic Tibase® customizable length <table border="1"> <tr><th>Abutment screw included</th><th>Height</th></tr> <tr><td></td><td>9.0 mm 31.313.115.21-2</td></tr> <tr><td></td><td>9.0 mm 31.323.115.21-2*</td></tr> </table>		Abutment screw included	Height		9.0 mm 31.313.115.21-2		9.0 mm 31.323.115.21-2*	EASY burn-out cap <table border="1"> <tr><th>Height</th><th>Cone</th></tr> <tr><td>ART 6.7 mm</td><td>6.0 mm 2.03.726</td></tr> <tr><td>ART 6.7 mm</td><td>6.0 mm 2.03.736*</td></tr> </table>		Height	Cone	ART 6.7 mm	6.0 mm 2.03.726	ART 6.7 mm	6.0 mm 2.03.736*	EASY analog <table border="1"> <tr><th>Cone</th></tr> <tr><td>ART 6.0 mm</td><td>3.03.706</td></tr> </table>		Cone	ART 6.0 mm	3.03.706	Implant analog <table border="1"> <tr><th>Length</th></tr> <tr><td>22.0 mm</td><td>3.03.065</td></tr> <tr><td>14.0 mm</td><td>3.03.091</td></tr> </table>		Length	22.0 mm	3.03.065	14.0 mm	3.03.091																
Abutment screw included	Cone	Height																																																																
	6.0 mm 9.0 mm	1.03.625																																																																
Abutment screw included	Height																																																																	
	12.0 mm 1.03.651																																																																	
Abutment screw included	Height																																																																	
	4.0 mm 31.313.115.01-2																																																																	
	4.0 mm 31.323.115.01-2*																																																																	
Abutment screw included	Height																																																																	
	9.0 mm 31.313.115.21-2																																																																	
	9.0 mm 31.323.115.21-2*																																																																	
Height	Cone																																																																	
ART 6.7 mm	6.0 mm 2.03.726																																																																	
ART 6.7 mm	6.0 mm 2.03.736*																																																																	
Cone																																																																		
ART 6.0 mm	3.03.706																																																																	
Length																																																																		
22.0 mm	3.03.065																																																																	
14.0 mm	3.03.091																																																																	
VARIOflex set <table border="1"> <tr><th>Abutment screw, burn-out cap included</th><th>Height</th></tr> <tr><td></td><td>12.0 mm 1.04.832</td></tr> <tr><td></td><td>12.0 mm 1.04.837*</td></tr> </table>			Abutment screw, burn-out cap included	Height		12.0 mm 1.04.832		12.0 mm 1.04.837*	Titanium Base CAD/CAM set <table border="1"> <tr><th>Abutment screw included</th><th>Height</th></tr> <tr><td></td><td>5.2 mm 1.04.752</td></tr> <tr><td></td><td>5.2 mm 1.04.762*</td></tr> </table>		Abutment screw included	Height		5.2 mm 1.04.752		5.2 mm 1.04.762*	Milling abutment for CAD/CAM Type II <table border="1"> <tr><th>Abutment screw included</th><th>Length</th><th>∅</th></tr> <tr><td></td><td>15.0 mm</td><td>11.5 mm 1.04.405</td></tr> </table>		Abutment screw included	Length	∅		15.0 mm	11.5 mm 1.04.405	VARIOeco burn-out cap <table border="1"> <tr><th>Height</th></tr> <tr><td>12.0 mm 2.03.792</td></tr> </table>		Height	12.0 mm 2.03.792	VARIOflex burn-out cap <table border="1"> <tr><th>Height</th></tr> <tr><td>11.5 mm 2.03.842</td></tr> </table>		Height	11.5 mm 2.03.842	Implant analog for CAD/CAM <table border="1"> <tr><th>Length</th></tr> <tr><td>11.4 mm</td><td>3.03.087</td></tr> </table>		Length	11.4 mm	3.03.087																													
Abutment screw, burn-out cap included	Height																																																																	
	12.0 mm 1.04.832																																																																	
	12.0 mm 1.04.837*																																																																	
Abutment screw included	Height																																																																	
	5.2 mm 1.04.752																																																																	
	5.2 mm 1.04.762*																																																																	
Abutment screw included	Length	∅																																																																
	15.0 mm	11.5 mm 1.04.405																																																																
Height																																																																		
12.0 mm 2.03.792																																																																		
Height																																																																		
11.5 mm 2.03.842																																																																		
Length																																																																		
11.4 mm	3.03.087																																																																	
VARIO abutment 17° set <table border="1"> <tr><th>∅</th><th>Height</th><th>Shoulder height</th><th>Type</th></tr> <tr><td>0°</td><td>5.6 mm</td><td>0.5 mm</td><td>1.03.162</td></tr> <tr><td>30°</td><td>5.6 mm</td><td>0.5 mm</td><td>1.03.182</td></tr> </table>			∅	Height	Shoulder height	Type	0°	5.6 mm	0.5 mm	1.03.162	30°	5.6 mm	0.5 mm	1.03.182	VARIO gold abutment, NOA <table border="1"> <tr><th>Height</th><th>Cone</th></tr> <tr><td>12.7 mm</td><td>3.5 mm 2.03.411</td></tr> <tr><td>12.7 mm</td><td>3.5 mm 2.03.401*</td></tr> </table>		Height	Cone	12.7 mm	3.5 mm 2.03.411	12.7 mm	3.5 mm 2.03.401*	VARIO 17° gold screw seat <table border="1"> <tr><th>Height</th><th>∅</th></tr> <tr><td>11.3 mm</td><td>2.9 mm 2.03.610</td></tr> </table>		Height	∅	11.3 mm	2.9 mm 2.03.610	Implant analog for CAD/CAM <table border="1"> <tr><th>Length</th></tr> <tr><td>11.4 mm</td><td>3.03.087</td></tr> </table>		Length	11.4 mm	3.03.087	Implant analog <table border="1"> <tr><th>Length</th></tr> <tr><td>22.0 mm</td><td>3.03.065</td></tr> <tr><td>14.0 mm</td><td>3.03.091</td></tr> </table>		Length	22.0 mm	3.03.065	14.0 mm	3.03.091																										
∅	Height	Shoulder height	Type																																																															
0°	5.6 mm	0.5 mm	1.03.162																																																															
30°	5.6 mm	0.5 mm	1.03.182																																																															
Height	Cone																																																																	
12.7 mm	3.5 mm 2.03.411																																																																	
12.7 mm	3.5 mm 2.03.401*																																																																	
Height	∅																																																																	
11.3 mm	2.9 mm 2.03.610																																																																	
Length																																																																		
11.4 mm	3.03.087																																																																	
Length																																																																		
22.0 mm	3.03.065																																																																	
14.0 mm	3.03.091																																																																	
VARIOmulti straight <table border="1"> <tr><th>Height</th><th>Shoulder height</th></tr> <tr><td>3.0 mm</td><td>0.8 mm 4.03.602</td></tr> <tr><td>4.2 mm</td><td>2.0 mm 4.03.607</td></tr> <tr><td>5.2 mm</td><td>3.0 mm 4.03.612</td></tr> </table>			Height	Shoulder height	3.0 mm	0.8 mm 4.03.602	4.2 mm	2.0 mm 4.03.607	5.2 mm	3.0 mm 4.03.612	VARIOmulti angled <table border="1"> <tr><th>Angle</th><th>Height</th><th>Shoulder height</th></tr> <tr><td>17°</td><td>4.3 mm</td><td>2.7 mm 4.03.682</td></tr> <tr><td>30°</td><td>4.4 mm</td><td>3.3 mm 4.03.687</td></tr> </table>		Angle	Height	Shoulder height	17°	4.3 mm	2.7 mm 4.03.682	30°	4.4 mm	3.3 mm 4.03.687	VARIOmulti gold abutment, NOA <table border="1"> <tr><th>Height</th><th>∅</th></tr> <tr><td>4.2/13.5 mm</td><td>4.8 mm 2.03.600</td></tr> </table>		Height	∅	4.2/13.5 mm	4.8 mm 2.03.600	VARIOmulti burn-out cap <table border="1"> <tr><th>Height</th><th>∅</th><th>pcs.</th></tr> <tr><td>13.5 mm</td><td>4.8 mm</td><td>2 2.03.601 02</td></tr> </table>		Height	∅	pcs.	13.5 mm	4.8 mm	2 2.03.601 02	VARIOmulti analog <table border="1"> <tr><th>Height</th><th>∅</th></tr> <tr><td>21.2 mm</td><td>4.8 mm 3.03.800</td></tr> </table>		Height	∅	21.2 mm	4.8 mm 3.03.800																									
Height	Shoulder height																																																																	
3.0 mm	0.8 mm 4.03.602																																																																	
4.2 mm	2.0 mm 4.03.607																																																																	
5.2 mm	3.0 mm 4.03.612																																																																	
Angle	Height	Shoulder height																																																																
17°	4.3 mm	2.7 mm 4.03.682																																																																
30°	4.4 mm	3.3 mm 4.03.687																																																																
Height	∅																																																																	
4.2/13.5 mm	4.8 mm 2.03.600																																																																	
Height	∅	pcs.																																																																
13.5 mm	4.8 mm	2 2.03.601 02																																																																
Height	∅																																																																	
21.2 mm	4.8 mm 3.03.800																																																																	
VARIOmulti titanium base for CAD/CAM <table border="1"> <tr><th>incl. occlusal screw</th><th>Height</th><th>∅</th></tr> <tr><td></td><td>4.5 mm</td><td>4.8 mm 1.04.850</td></tr> </table>			incl. occlusal screw	Height	∅		4.5 mm	4.8 mm 1.04.850	VARIOmulti titanium base for CAD/CAM, customizable length <table border="1"> <tr><th>incl. occlusal screw</th><th>Height</th><th>∅</th></tr> <tr><td></td><td>9.0 mm</td><td>4.8 mm 1.04.851</td></tr> </table>		incl. occlusal screw	Height	∅		9.0 mm	4.8 mm 1.04.851	VARIOmulti analog for CAD/CAM <table border="1"> <tr><th>Height</th><th>∅</th></tr> <tr><td>13.2 mm</td><td>4.8 mm 3.03.083</td></tr> </table>		Height	∅	13.2 mm	4.8 mm 3.03.083																																												
incl. occlusal screw	Height	∅																																																																
	4.5 mm	4.8 mm 1.04.850																																																																
incl. occlusal screw	Height	∅																																																																
	9.0 mm	4.8 mm 1.04.851																																																																
Height	∅																																																																	
13.2 mm	4.8 mm 3.03.083																																																																	
LOCATOR® abutment <table border="1"> <tr><th>Height</th></tr> <tr><td>1.0 mm</td><td>8786</td></tr> <tr><td>2.0 mm</td><td>8787</td></tr> <tr><td>3.0 mm</td><td>8788</td></tr> <tr><td>4.0 mm</td><td>8789</td></tr> <tr><td>5.0 mm</td><td>8790</td></tr> <tr><td>6.0 mm</td><td>8791</td></tr> </table>			Height	1.0 mm	8786	2.0 mm	8787	3.0 mm	8788	4.0 mm	8789	5.0 mm	8790	6.0 mm	8791	Retentive anchor abutment <table border="1"> <tr><th>Height</th></tr> <tr><td>1.8 mm</td><td>4.03.040</td></tr> <tr><td>3.0 mm</td><td>4.03.041</td></tr> </table>		Height	1.8 mm	4.03.040	3.0 mm	4.03.041	RETAIN Milling abutment <table border="1"> <tr><th>Height</th></tr> <tr><td>12.0 mm</td><td>4.03.421</td></tr> </table>		Height	12.0 mm	4.03.421	LOCATOR® For components, see: thommenmedical.com or product catalogue																																						
Height																																																																		
1.0 mm	8786																																																																	
2.0 mm	8787																																																																	
3.0 mm	8788																																																																	
4.0 mm	8789																																																																	
5.0 mm	8790																																																																	
6.0 mm	8791																																																																	
Height																																																																		
1.8 mm	4.03.040																																																																	
3.0 mm	4.03.041																																																																	
Height																																																																		
12.0 mm	4.03.421																																																																	
RETAIN Bar abutment <table border="1"> <tr><th>Height</th></tr> <tr><td>5.5 mm</td><td>4.03.381</td></tr> </table>			Height	5.5 mm	4.03.381	RETAIN Coping for bar <table border="1"> <tr><th>Gold</th><th>Titanium</th></tr> <tr><td>2.03.335</td><td>4.03.070</td></tr> </table>		Gold	Titanium	2.03.335	4.03.070	Retentive anchor Analog <table border="1"> <tr><th>Length</th></tr> <tr><td>13.0 mm</td><td>3.03.033</td></tr> </table>		Length	13.0 mm	3.03.033	LOCATOR® analog <table border="1"> <tr><th>∅</th><th>pcs.</th></tr> <tr><td>4.0 mm</td><td>4 8530</td></tr> <tr><td>5.0 mm</td><td>4 8516</td></tr> </table>		∅	pcs.	4.0 mm	4 8530	5.0 mm	4 8516																																										
Height																																																																		
5.5 mm	4.03.381																																																																	
Gold	Titanium																																																																	
2.03.335	4.03.070																																																																	
Length																																																																		
13.0 mm	3.03.033																																																																	
∅	pcs.																																																																	
4.0 mm	4 8530																																																																	
5.0 mm	4 8516																																																																	

Prosthetic overview PF 5.0

Screws	Gingiva former
<p>Occlusal screw</p>  <p>Length 3.5 mm 4.03.507</p>	<p>Applicable for all restorations</p> <p>Gingiva former customizable</p>  <p>Height 7.5 mm 4.03.573</p>
<p>Screw for bar</p>  <p>Length 4.3 mm 4.03.506</p>	<p>Healing cap SE</p>  <p>Height 1.0 mm 4.03.5175</p>
<p>Abutment screw</p>  <p>Length 7.2 mm 4.03.501 10.2 mm 4.03.502</p>	<p>Gingiva former</p>  <p>Height 2.0 mm 4.03.5225 3.2 mm 4.03.5325 4.5 mm 4.03.5425 5.7 mm 4.03.5625 7.0 mm 4.03.5525</p>
<p>VARIOmulti fabrication screw</p>  <p>Length Pcs. 19.3 mm 4 3.03.598 04</p>	<p>Gingiva former narrow</p>  <p>Height 2.0 mm 4.04.3135 3.2 mm 4.04.3235 4.5 mm 4.04.3335 5.7 mm 4.04.3435 7.0 mm 4.04.3535</p>
<p>Laboratory screw</p>  <p>Length 25.0 mm 3.03.516</p>	
<p>Fabrication screw</p>  <p>Length Pcs. 23.4 mm 4 3.03.591 04</p>	
<p>Dynamic Abutment screw</p>  <p>Length 7.2 mm 41.316.076.02-2</p>	

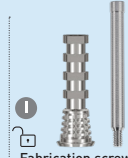
	Impression taking																																
Cemented	<p>EASY impression coping</p>  <table border="1"> <thead> <tr> <th></th> <th>Height</th> <th>Cone</th> <th></th> </tr> </thead> <tbody> <tr> <td>EASY</td> <td>9.5 mm</td> <td>4.0 mm</td> <td>2.03.702</td> </tr> <tr> <td>EASY</td> <td>11.5 mm</td> <td>6.0 mm</td> <td>2.03.706</td> </tr> <tr> <td>EASY e.p.</td> <td>9.5 mm</td> <td>4.0 mm</td> <td>2.03.703</td> </tr> <tr> <td>EASY e.p./ART</td> <td>11.5 mm</td> <td>6.0 mm</td> <td>2.03.707</td> </tr> </tbody> </table>		Height	Cone		EASY	9.5 mm	4.0 mm	2.03.702	EASY	11.5 mm	6.0 mm	2.03.706	EASY e.p.	9.5 mm	4.0 mm	2.03.703	EASY e.p./ART	11.5 mm	6.0 mm	2.03.707												
		Height	Cone																														
EASY	9.5 mm	4.0 mm	2.03.702																														
EASY	11.5 mm	6.0 mm	2.03.706																														
EASY e.p.	9.5 mm	4.0 mm	2.03.703																														
EASY e.p./ART	11.5 mm	6.0 mm	2.03.707																														
Screw-retained & cemented	<p>Impression copings</p>  <table border="1"> <thead> <tr> <th></th> <th>Alu</th> <th>Titanium</th> <th></th> </tr> </thead> <tbody> <tr> <td>Titanium</td> <td>Conical 3.04.033</td> <td>Conical 3.04.049</td> <td>Conical 3.03.072</td> </tr> <tr> <td>Alu</td> <td>Conical 3.03.076</td> <td>Conical 3.03.016</td> <td>Parallel 3.03.012</td> </tr> <tr> <td></td> <td></td> <td>Parallel 3.04.023</td> <td>Parallel 3.04.023</td> </tr> <tr> <td></td> <td></td> <td></td> <td>3.03.575</td> </tr> <tr> <td></td> <td></td> <td></td> <td>3.03.576</td> </tr> <tr> <td></td> <td></td> <td></td> <td>3.03.577</td> </tr> <tr> <td></td> <td></td> <td></td> <td>3.03.581</td> </tr> </tbody> </table> <p>Scan abutment 50 Stainless steel, coated 3.03.778</p> <p>Screw for impression coping Length 13.2 mm 3.03.575</p>		Alu	Titanium		Titanium	Conical 3.04.033	Conical 3.04.049	Conical 3.03.072	Alu	Conical 3.03.076	Conical 3.03.016	Parallel 3.03.012			Parallel 3.04.023	Parallel 3.04.023				3.03.575				3.03.576				3.03.577				3.03.581
		Alu	Titanium																														
Titanium	Conical 3.04.033	Conical 3.04.049	Conical 3.03.072																														
Alu	Conical 3.03.076	Conical 3.03.016	Parallel 3.03.012																														
		Parallel 3.04.023	Parallel 3.04.023																														
			3.03.575																														
			3.03.576																														
			3.03.577																														
			3.03.581																														
Screw-retained	<p>Impression copings</p>  <table border="1"> <thead> <tr> <th></th> <th>Alu</th> <th>Titanium</th> <th></th> </tr> </thead> <tbody> <tr> <td>Titanium</td> <td>Conical 3.04.033</td> <td>Conical 3.04.049</td> <td>Conical 3.03.072</td> </tr> <tr> <td>Alu</td> <td>Conical 3.03.076</td> <td>Conical 3.03.016</td> <td>Parallel 3.03.012</td> </tr> <tr> <td></td> <td></td> <td>Parallel 3.04.023</td> <td>Parallel 3.04.023</td> </tr> <tr> <td></td> <td></td> <td></td> <td>3.03.575</td> </tr> <tr> <td></td> <td></td> <td></td> <td>3.03.576</td> </tr> <tr> <td></td> <td></td> <td></td> <td>3.03.577</td> </tr> <tr> <td></td> <td></td> <td></td> <td>3.03.581</td> </tr> </tbody> </table>		Alu	Titanium		Titanium	Conical 3.04.033	Conical 3.04.049	Conical 3.03.072	Alu	Conical 3.03.076	Conical 3.03.016	Parallel 3.03.012			Parallel 3.04.023	Parallel 3.04.023				3.03.575				3.03.576				3.03.577				3.03.581
		Alu	Titanium																														
Titanium	Conical 3.04.033	Conical 3.04.049	Conical 3.03.072																														
Alu	Conical 3.03.076	Conical 3.03.016	Parallel 3.03.012																														
		Parallel 3.04.023	Parallel 3.04.023																														
			3.03.575																														
			3.03.576																														
			3.03.577																														
			3.03.581																														
Overdenture	<p>VARIOmulti impression coping</p>  <p>Height 18.0 mm 3.04.805</p> <p>Height 3.03.572 3.03.573 3.03.574 3.03.580</p> <p>VARIOmulti Scan abutment Height 8.0 mm 4.5 mm 3.03.780</p> <p>VARIOmulti Scan abutment, short Height 5.0 mm 5.0 mm 3.03.781</p>																																
	<p>LOCATOR® Abutment impression coping</p>  <p>Alu 4 pcs. 8505</p> <p>LOCATOR® Bar abutment Impression coping</p>  <p>Height 5.0 mm 6.0 mm 3.03.101</p>																																

Temp. restoration	Temp. restoration																				
<p>EASY temporary cap</p>  <table border="1"> <thead> <tr> <th></th> <th>Height</th> <th>Cone</th> <th></th> </tr> </thead> <tbody> <tr> <td>EASY</td> <td>5.0 mm</td> <td>4.0 mm</td> <td>2.03.742</td> </tr> <tr> <td>EASY</td> <td>7.0 mm</td> <td>6.0 mm</td> <td>2.03.746</td> </tr> <tr> <td>EASY e.p.</td> <td>5.0 mm</td> <td>4.0 mm</td> <td>2.03.743</td> </tr> <tr> <td>EASY e.p./ART</td> <td>7.0 mm</td> <td>6.0 mm</td> <td>2.03.747</td> </tr> </tbody> </table>		Height	Cone		EASY	5.0 mm	4.0 mm	2.03.742	EASY	7.0 mm	6.0 mm	2.03.746	EASY e.p.	5.0 mm	4.0 mm	2.03.743	EASY e.p./ART	7.0 mm	6.0 mm	2.03.747	<p>VARIOtemp set</p>  <p>Fabrication screw included Height 12.0 mm 1.04.083 12.0 mm 1.04.088*</p>
	Height	Cone																			
EASY	5.0 mm	4.0 mm	2.03.742																		
EASY	7.0 mm	6.0 mm	2.03.746																		
EASY e.p.	5.0 mm	4.0 mm	2.03.743																		
EASY e.p./ART	7.0 mm	6.0 mm	2.03.747																		
	<p>VARIOtemp set</p>  <p>Fabrication screw included Height 12.0 mm 1.04.083 12.0 mm 1.04.088*</p>																				
	<p>VARIOmulti protective cap</p>  <p>Height 4.5 mm 4.03.801</p> <p>VARIOmulti temp. cap</p>  <p>Fabrication screw included Height 15.0 mm 3.03.804</p>																				
	<p>LOCATOR®</p>  <p>20 pcs. 8515-20</p>																				

NOTICE:

- For information on customized CAD/CAM solutions, visit: www.thommenmedical.com.
- In each case, the symbols correspond to required components, which can be ordered separately **I** - **VII**.
- Rotation locked Rotation unlocked
- x.xx.xxxS Sterile packed **STERILE**

Final restoration

EASY abutment

Collar	Cone	Height
short 0.5 mm	4.0 mm 4.5 mm	4.03.702
short 0.5 mm	6.0 mm 6.5 mm	4.03.706
long 2.0 mm	4.0 mm 6.0 mm	4.03.712
long 2.0 mm	6.0 mm 8.0 mm	4.03.716
extra long 4.0 mm	6.0 mm 10.0 mm	4.03.736

EASY abutment 20°

Collar	Height
20° short 0.5 mm	6.5 mm 4.03.012
20° long 3.0 mm	9.0 mm 4.03.016

EASY abutment set

Collar	Cone	Height
short 0.5 mm	4.0 mm 4.5 mm	1.04.702
short 0.5 mm	6.0 mm 6.5 mm	1.04.706
long 2.0 mm	4.0 mm 6.0 mm	1.04.712
long 2.0 mm	6.0 mm 8.0 mm	1.04.716
extra long 4.0 mm	6.0 mm 10.0 mm	1.04.736

Set contents:

- EASY abutment
- abutment screw
- EASY impression coping
- EASY analog
- EASY temporary cap
- EASY burn-out cap for crown
- EASY burn-out cap for bridge

EASY abutment e.p.

Height	Cone
7.0 mm	4.0 mm 4.03.722
9.0 mm	6.0 mm 4.03.726

Burn-out cap

EASY burn-out cap

Height	Cone
4.7 mm	4.0 mm 2.03.722
6.7 mm	6.0 mm 2.03.726
4.7 mm	4.0 mm 2.03.732*
6.7 mm	6.0 mm 2.03.736*
EASY e.p. 4.7 mm	4.0 mm 2.03.723
EASY e.p. 6.7 mm	6.0 mm 2.03.727
EASY e.p. 4.7 mm	4.0 mm 2.03.733*
EASY e.p. 6.7 mm	6.0 mm 2.03.737*

Analog

EASY analog

Cone
4.0 mm 3.03.702
6.0 mm 3.03.706
EASY e.p. 4.0 mm 3.03.703
EASY e.p. 6.0 mm 3.03.707

Implant analog

Length
22.0 mm 3.03.062
14.0 mm 3.03.092

Implant analog for CAD/CAM

Length
11.4 mm 3.03.088

ART abutment set

Cone	Height
6.0 mm 9.0 mm	1.03.626

ART grinding cylinder set

Height
12.0 mm 1.03.652*

Dynamic Tibase®

Height
4.0 mm 31.314.116.01-2
4.0 mm 31.324.116.01-2*

Dynamic Tibase® customizable length

Height
9.0 mm 31.314.116.21-2
9.0 mm 31.324.116.21-2*

VARIOflex set

Height
12.0 mm 1.04.833
12.0 mm 1.04.838*

Titanium Base CAD/CAM set

Height
5.2 mm 1.04.753
5.2 mm 1.04.763*

Milling abutment for CAD/CAM Type II

Length	∅
15.0 mm 11.5 mm	1.04.407

EASY burn-out cap

Height	Cone
6.7 mm	6.0 mm 2.03.727
6.7 mm	6.0 mm 2.03.737*

EASY analog

Cone
6.0 mm 3.03.707

Implant analog

Length
22.0 mm 3.03.062
14.0 mm 3.03.092

Implant analog for CAD/CAM

Length
11.4 mm 3.03.088

VARIO abutment 17° set

∅	Height	Shoulder height	Type
0°	5.6 mm	0.5 mm	1.03.163
30°	5.6 mm	0.5 mm	1.03.183

Set contents:

- VARIO abutment 17° (titanium)
- VARIO 17° gold screw seat
- occlusal screw
- abutment screw

VARIO gold abutment, NOA

Height	Cone
12.7 mm	3.5 mm 2.03.412
12.7 mm	3.5 mm 2.03.402*

VARIO 17° gold screw seat

Height	∅
11.3 mm	2.9 mm 2.03.610

Implant analog for CAD/CAM

Length
11.4 mm 3.03.088

Implant analog

Length
22.0 mm 3.03.062
14.0 mm 3.03.092

VARIOmulti straight

Height	Shoulder height
3.0 mm 0.8 mm	4.03.603
4.2 mm 2.0 mm	4.03.608
5.2 mm 3.0 mm	4.03.613

VARIOmulti angled

Angle	Height	Shoulder height
17°	4.3 mm 2.7 mm	4.03.683
30°	4.4 mm 3.3 mm	4.03.688

VARIOmulti gold abutment, NOA

Height	∅
4.2/13.5 mm	4.8 mm 2.03.600

VARIOmulti titanium base for CAD/CAM

Height	∅
4.5 mm 4.8 mm	1.04.850

VARIOmulti titanium base for CAD/CAM, customizable length

Height	∅
9.0 mm 4.8 mm	1.04.851

VARIOmulti burn-out cap

Height	∅	pcs.
13.5 mm	4.8 mm	2 2.03.601 02

VARIOmulti analog

Height	∅
21.2 mm 4.8 mm	3.03.800

VARIOmulti analog for CAD/CAM

Height	∅
13.2 mm 4.8 mm	3.03.083

LOCATOR® abutment

Height
1.0 mm 8792
2.0 mm 8793
3.0 mm 8794
4.0 mm 8795
5.0 mm 8796
6.0 mm 8797

Retentive anchor® abutment

Height
1.8 mm 4.03.042
3.0 mm 4.03.043

RETAIN

Milling abutment

Height
12.0 mm 4.03.422

Bar abutment

Height
5.5 mm 4.03.382

Coping for bar

Gold	Titanium
2.03.335	4.03.070

LOCATOR® analog

Length
13.0 mm 3.03.033









Retentive anchor Analog







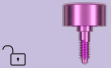





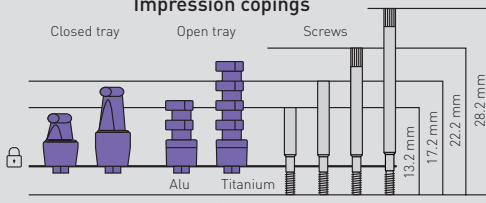

Length
13.0 mm 3.03.033

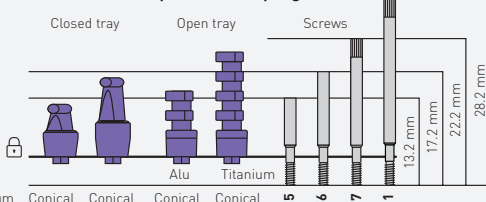
LOCATOR® analog

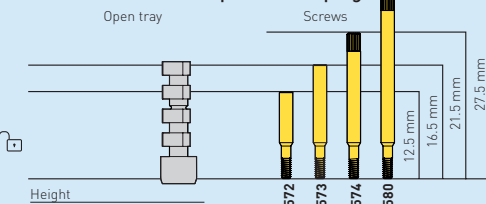
∅	Pcs.
4.0 mm 4	8530
5.0 mm 4	8516

Prosthetic overview PF 6.0

Screws	Gingiva former
<p>Occlusal screw</p>  <p>Length 3.5 mm 4.03.507</p>	<p>Applicable for all restorations</p> <p>Gingiva former customizable</p>  <p>Height 7.5 mm 4.03.574</p>
<p>Screw for bar</p>  <p>Length 4.3 mm 4.03.506</p>	<p>Healing cap SE</p>  <p>Height 1.0 mm 4.03.5185</p>
<p>Abutment screw</p>  <p>Length 7.2 mm 4.03.501 10.2 mm 4.03.502</p>	<p>Gingiva former</p>  <p>Height 2.0 mm 4.03.5235 3.2 mm 4.03.5335 4.5 mm 4.03.5435 5.7 mm 4.03.5635 7.0 mm 4.03.5535</p>
<p>VARIOmulti fabrication screw</p>  <p>Length Pcs. 19.3 mm 4 3.03.598 Q4</p>	<p>Gingiva former narrow</p>  <p>Height 2.0 mm 4.04.3145 3.2 mm 4.04.3245 4.5 mm 4.04.3345 5.7 mm 4.04.3445 7.0 mm 4.04.3545</p>
<p>Laboratory screw</p>  <p>Length 25.0 mm 3.03.516</p>	
<p>Fabrication screw</p>  <p>Length Pcs. 23.4 mm 4 3.03.591 Q4</p>	

	Impression taking	Temp. restoration																																	
Cemented	<p>EASY impression coping</p>  <table border="1"> <tr> <th>Height</th> <th>Cone</th> <th></th> </tr> <tr> <td>9.5 mm</td> <td>4.0 mm</td> <td>2.03.703</td> </tr> <tr> <td>11.5 mm</td> <td>6.0 mm</td> <td>2.03.707</td> </tr> </table>	Height	Cone		9.5 mm	4.0 mm	2.03.703	11.5 mm	6.0 mm	2.03.707	<p>EASY temporary cap</p>  <table border="1"> <tr> <th>Height</th> <th>Cone</th> <th></th> </tr> <tr> <td>5.0 mm</td> <td>4.0 mm</td> <td>2.03.743</td> </tr> <tr> <td>7.0 mm</td> <td>6.0 mm</td> <td>2.03.747</td> </tr> </table>	Height	Cone		5.0 mm	4.0 mm	2.03.743	7.0 mm	6.0 mm	2.03.747															
	Height	Cone																																	
9.5 mm	4.0 mm	2.03.703																																	
11.5 mm	6.0 mm	2.03.707																																	
Height	Cone																																		
5.0 mm	4.0 mm	2.03.743																																	
7.0 mm	6.0 mm	2.03.747																																	
Screw-retained & cemented	<p>Impression copings</p>  <table border="1"> <tr> <th></th> <th>Alu</th> <th>Titanium</th> <th></th> </tr> <tr> <td>Titanium</td> <td>Conical 3.04.034</td> <td>Conical 3.04.050</td> <td>Conical 3.03.073</td> </tr> <tr> <td></td> <td>Conical 3.03.077</td> <td>Conical 3.03.017</td> <td>Conical 3.04.040</td> </tr> <tr> <td>Alu</td> <td>Conical 3.03.077</td> <td>Conical 3.03.017</td> <td>Parallel 3.03.013</td> </tr> <tr> <td></td> <td>Parallel 3.03.013</td> <td>Parallel 3.04.024</td> <td>Parallel 3.03.077</td> </tr> <tr> <td></td> <td></td> <td></td> <td>Parallel 3.03.581</td> </tr> </table>		Alu	Titanium		Titanium	Conical 3.04.034	Conical 3.04.050	Conical 3.03.073		Conical 3.03.077	Conical 3.03.017	Conical 3.04.040	Alu	Conical 3.03.077	Conical 3.03.017	Parallel 3.03.013		Parallel 3.03.013	Parallel 3.04.024	Parallel 3.03.077				Parallel 3.03.581	<p>VARIOtemp set</p>  <p>Fabrication screw included</p> <table border="1"> <tr> <th>Height</th> <th></th> </tr> <tr> <td>12.0 mm</td> <td>1.04.084</td> </tr> <tr> <td>12.0 mm</td> <td>1.04.089*</td> </tr> </table>	Height		12.0 mm	1.04.084	12.0 mm	1.04.089*			
		Alu	Titanium																																
Titanium	Conical 3.04.034	Conical 3.04.050	Conical 3.03.073																																
	Conical 3.03.077	Conical 3.03.017	Conical 3.04.040																																
Alu	Conical 3.03.077	Conical 3.03.017	Parallel 3.03.013																																
	Parallel 3.03.013	Parallel 3.04.024	Parallel 3.03.077																																
			Parallel 3.03.581																																
Height																																			
12.0 mm	1.04.084																																		
12.0 mm	1.04.089*																																		
Screw-retained	<p>Scan abutment</p>  <p>Stainless steel, coated 3.03.779</p>	<p>Screw for impression coping</p>  <p>Length 13.2 mm 3.03.575</p>																																	
	<p>Impression copings</p>  <table border="1"> <tr> <th></th> <th>Alu</th> <th>Titanium</th> <th></th> </tr> <tr> <td>Titanium</td> <td>Conical 3.04.034</td> <td>Conical 3.04.050</td> <td>Conical 3.03.073</td> </tr> <tr> <td></td> <td>Conical 3.03.077</td> <td>Conical 3.03.017</td> <td>Conical 3.04.040</td> </tr> <tr> <td>Alu</td> <td>Conical 3.03.077</td> <td>Conical 3.03.017</td> <td>Conical 3.03.575</td> </tr> <tr> <td></td> <td>Parallel 3.03.013</td> <td>Parallel 3.04.024</td> <td>Parallel 3.03.576</td> </tr> <tr> <td></td> <td></td> <td></td> <td>Parallel 3.03.577</td> </tr> <tr> <td></td> <td></td> <td></td> <td>Parallel 3.03.581</td> </tr> </table>		Alu	Titanium		Titanium	Conical 3.04.034	Conical 3.04.050	Conical 3.03.073		Conical 3.03.077	Conical 3.03.017	Conical 3.04.040	Alu	Conical 3.03.077	Conical 3.03.017	Conical 3.03.575		Parallel 3.03.013	Parallel 3.04.024	Parallel 3.03.576				Parallel 3.03.577				Parallel 3.03.581	<p>VARIOtemp set</p>  <p>Fabrication screw included</p> <table border="1"> <tr> <th>Height</th> <th></th> </tr> <tr> <td>12.0 mm</td> <td>1.04.084</td> </tr> <tr> <td>12.0 mm</td> <td>1.04.089*</td> </tr> </table>	Height		12.0 mm	1.04.084	12.0 mm
	Alu	Titanium																																	
Titanium	Conical 3.04.034	Conical 3.04.050	Conical 3.03.073																																
	Conical 3.03.077	Conical 3.03.017	Conical 3.04.040																																
Alu	Conical 3.03.077	Conical 3.03.017	Conical 3.03.575																																
	Parallel 3.03.013	Parallel 3.04.024	Parallel 3.03.576																																
			Parallel 3.03.577																																
			Parallel 3.03.581																																
Height																																			
12.0 mm	1.04.084																																		
12.0 mm	1.04.089*																																		
VARIOmulti	<p>VARIOmulti impression coping</p>  <table border="1"> <tr> <th>Height</th> <th></th> </tr> <tr> <td>18.0 mm</td> <td>3.04.805</td> </tr> <tr> <td></td> <td>3.03.572</td> </tr> <tr> <td></td> <td>3.03.573</td> </tr> <tr> <td></td> <td>3.03.574</td> </tr> <tr> <td></td> <td>3.03.580</td> </tr> </table>	Height		18.0 mm	3.04.805		3.03.572		3.03.573		3.03.574		3.03.580	<p>VARIOmulti protective cap</p>  <p>Height 4.5 mm 4.03.801</p>																					
	Height																																		
18.0 mm	3.04.805																																		
	3.03.572																																		
	3.03.573																																		
	3.03.574																																		
	3.03.580																																		
Overdenture	<p>VARIOmulti Scan abutment</p>  <table border="1"> <tr> <th>Height</th> <th>Ø</th> <th></th> </tr> <tr> <td>8.0 mm</td> <td>4.5 mm</td> <td>3.03.780</td> </tr> </table>	Height	Ø		8.0 mm	4.5 mm	3.03.780	<p>VARIOmulti Scan abutment, short</p>  <table border="1"> <tr> <th>Height</th> <th>Ø</th> <th></th> </tr> <tr> <td>5.0 mm</td> <td>5.0 mm</td> <td>3.03.781</td> </tr> </table>	Height	Ø		5.0 mm	5.0 mm	3.03.781																					
	Height	Ø																																	
8.0 mm	4.5 mm	3.03.780																																	
Height	Ø																																		
5.0 mm	5.0 mm	3.03.781																																	
	<p>LOCATOR® abutment Impression coping</p>  <p>Alu 4 pcs. 8505</p>	<p>LOCATOR®</p>  <p>20 pcs. 8515-20</p>  <p>Block-out spacer 20 pcs. 8514</p>																																	

NOTICE:

- For information on customized CAD/CAM solutions, visit: www.thommenmedical.com.
- In each case, the symbols correspond to required components, which can be ordered separately **I** – **VI**.
- **Rotation locked** **Rotation unlocked**
- x.xx.xxx Sterile packed **STERILE**

Final restoration

EASY abutment



Collar	Cone	Height	
short 0.5 mm	4.0 mm	4.5 mm	4.03.703
short 0.5 mm	6.0 mm	6.5 mm	4.03.707
long 2.0 mm	4.0 mm	6.0 mm	4.03.713
long 2.0 mm	6.0 mm	8.0 mm	4.03.717

EASY abutment 20°



Collar	Height	
20° short 0.5 mm	6.5 mm	4.03.013
20° long 3.0 mm	9.0 mm	4.03.017

EASY abutment set



Set contents:

- EASY abutment
- abutment screw
- EASY impression coping
- EASY analog
- EASY temporary cap
- EASY burn-out cap, for crown, burn-out plastic
- EASY burn-out cap, for bridge, burn-out plastic

Collar	Cone	Height	
short 0.5 mm	4.0 mm	4.5 mm	1.04.703
short 0.5 mm	6.0 mm	6.5 mm	1.04.707
long 2.0 mm	4.0 mm	6.0 mm	1.04.713
long 2.0 mm	6.0 mm	8.0 mm	1.04.717

Burn-out cap

EASY burn-out cap



Height	Cone	
4.7 mm	4.0 mm	2.03.723
6.7 mm	6.0 mm	2.03.727
4.7 mm	4.0 mm	2.03.733*
6.7 mm	6.0 mm	2.03.737*

Analog

EASY analog



Cone	
4.0 mm	3.03.703
6.0 mm	3.03.707

Implant analog



Length	
22.0 mm	3.03.063
15.0 mm	3.03.093

Implant analog for CAD/CAM



Length	
11.4 mm	3.03.089

VARIOflex set



Abutment screw, burn-out cap included

Height	
12.0 mm	1.04.834
12.0 mm	1.04.839*

Titanium Base CAD/CAM Set



Abutment screw included

Height	
5.2 mm	1.04.754
5.2 mm	1.04.764*

Milling abutment for CAD/CAM Type II



Abutment screw included

Length	∅	
15.0 mm	11.5 mm	1.04.409

VARIOeco burn-out cap



Height	
12.0 mm	2.03.794

VARIOflex burn-out cap



Height	
11.5 mm	2.03.844

Implant analog



Length	
22.0 mm	3.03.063
15.0 mm	3.03.093

Implant analog for CAD/CAM



Length	
11.4 mm	3.03.089

VARIO gold abutment, NOA



Height	Cone	
12.7 mm	3.5 mm	2.03.413
12.7 mm	3.5 mm	2.03.403*

Implant analog for CAD/CAM



Length	
11.4 mm	3.03.089

Implant analog



Length	
22.0 mm	3.03.063
15.0 mm	3.03.093

VARIOmulti straight



Height	Shoulder height	
3.7 mm	1.5 mm	4.03.604

VARIOmulti angled



Angle	Height	Shoulder height	
17°	4.3 mm	2.7 mm	4.03.684
30°	4.4 mm	3.3 mm	4.03.689

VARIOmulti gold abutment, NOA



Height	∅	
4.2/13.5 mm	4.8 mm	2.03.600

VARIOmulti titanium base for CAD/CAM



incl. occlusal screw

Height	∅	
4.5 mm	4.8 mm	1.04.850

VARIOmulti titanium base for CAD/CAM, customizable length



incl. occlusal screw

Height	∅	
9.0 mm	4.8 mm	1.04.851

VARIOmulti burn-out cap



Height	∅	pcs.	
13.5 mm	4.8 mm	2	2.03.601 02

VARIOmulti analog



Height	∅	
21.2 mm	4.8 mm	3.03.800

VARIOmulti analog for CAD/CAM



Height	∅	
13.2 mm	4.8 mm	3.03.083

LOCATOR® abutment



Height	
1.0 mm	8881
2.0 mm	8882
3.0 mm	8883
4.0 mm	8884

RETAIN milling abutment



Height	
12.0 mm	4.03.423

LOCATOR®

For components, see: thommenmedical.com or product catalogue

LOCATOR® analog





∅	Pcs.	
4.0 mm	4	8530
5.0 mm	4	8516

SPI®VARIOtemp

for temporary restorations

www.ifu-tm.com/THM61121

 Rotation locked
 Rotation unlocked

PF 3.5

PF 4.0

PF 4.5

PF 5.0

PF 6.0

 **Important** Do not use abutments designed for single crowns with screw-retained bridge constructions, as axial divergences cannot be bridged.

 **VARIOtemp abutment set for crown**, titanium/stainless steel



Height

12.0 mm

1.04.080

1.04.081

1.04.082

1.04.083

1.04.084



Set contents:

- 1 abutment
- 1 fabrication screw

Abutment screw is not included in delivery. Always use new abutment screws for the final insertion of abutments.

 **VARIOtemp abutment set for bridge**, titanium/stainless steel



Height

12.0 mm

1.04.085

1.04.086

1.04.087

1.04.088

1.04.089



Set contents:

- 1 abutment
- 1 fabrication screw

Abutment screw is not included in delivery. Always use new abutment screws for the final insertion of abutments.

Abutment screw, 4-lobe, titanium alloy



Length

5.8 mm

4.03.500

7.2 mm

4.03.501

10.2 mm



4.03.502

 **Important** Thommen Medical provides the corresponding CAD libraries. You can find an overview at: www.thommenmedical.com.

Titanium Base for CAD/CAM

for cemented and screw-retained restorations

www.ifu-tm.com/THM61123

 Rotation locked
 Rotation unlocked

PF 3.5

PF 4.0

PF 4.5

PF 5.0

PF 6.0

 **Important** Do not use abutments designed for single crowns with screw-retained bridge constructions, as axial divergences cannot be bridged.

 **Titanium Base with hexagon for CAD/CAM**, incl. abutment screw, titanium



Height

5.2 mm

1.04.750

1.04.751

1.04.752

1.04.753

1.04.754



 **Titanium Base bridge for CAD/CAM**, incl. abutment screw, titanium



Height

5.2 mm

1.04.760

1.04.761

1.04.762

1.04.763

1.04.764



Abutment screw, 4-lobe, titanium alloy



Length

5.8 mm

4.03.500

7.2 mm

4.03.501

10.2 mm

4.03.502

Laboratory screw, stainless steel, 5 per pack (Q5)



Length

25.0 mm

3.03.515

3.03.516

25.0 mm

3.03.515 Q5

3.03.516 Q5

Laboratory cylindrical pin, PTFE, 5 per pack (Q5)

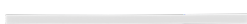

Length

70.0 mm

2.03.450 Q5

2.03.451 Q5

 **VARIOeco burn-out plastic cap**, for Titanium Base, POM



Height

12.0 mm

2.03.790

2.03.791

2.03.792

2.03.793



2.03.794

Burn-out fabrication cap for the conventional fabrication of frameworks on the Titanium Base.

 **Important** Thommen Medical provides the corresponding CAD libraries. You can find an overview at: www.thommenmedical.com.

Dynamic Titanium Base for CAD/CAM

www.dynamicabutment.com

 Rotation locked
 Rotation unlocked

PF 3.5

PF 4.0

PF 4.5

PF 5.0

PF 6.0

 **Important** Do not use abutments designed for single crowns with screw-retained bridge constructions, as axial divergences cannot be bridged.

 **Dynamic Titanium Base for crown**, incl. Dynamic abutment screw, titanium alloy



digital

Height

4.0 mm

31.311.113.01-2

31.312.114.01-2

31.313.115.01-2

31.314.116.01-2

 **Dynamic Titanium Base for bridge**, incl. Dynamic abutment screw, titanium alloy



digital

Height

4.0 mm

31.321.113.01-2

31.322.114.01-2

31.323.115.01-2

31.324.116.01-2

 **Dynamic Titanium Base for crown**, customizable length, incl. Dynamic abutment screw, titanium alloy



digital

Height

9.0 mm

31.310.113.21-2

31.312.114.21-2

31.313.115.21-2

31.314.116.21-2

 **Dynamic Titanium Base for bridge**, customizable length, incl. Dynamic abutment screw, titanium alloy



digital

Height

9.0 mm

31.320.113.21-2

31.322.114.21-2

31.323.115.21-2

31.324.116.21-2

Dynamic abutment screw, hexagonal, titanium alloy



Length

6.6 mm

41.314.069.01-2



7.2 mm

41.316.076.02-2

Dynamic screwdriver, stainless steel



Length

18.0 mm

43.618.201.01-2

24.0 mm

43.624.201.01-2

32.0 mm

43.632.201.01-2



All latch-type instruments can be utilized with the MONO insertion device, short (art. no. 3.03.162), and with the MONO torque ratchet (art. no. 3.03.160).

 **Important** Thommen Medical provides the corresponding CAD libraries. You can find an overview at: www.thommenmedical.com.

Milling abutment for CAD/CAM Type II

for customized abutments

www.ifu-tm.com/THM61137

 Rotation locked
 Rotation unlocked

PF 3.5	PF 4.0	PF 4.5	PF 5.0	PF 6.0
--------	--------	--------	--------	--------

Milling abutment for CAD/CAM Type II, incl. abutment screw, titanium



Length	Ø	PF 3.5	PF 4.0	PF 4.5	PF 5.0	PF 6.0
15.0 mm	8.0 mm	1.04.401				
15.0 mm	11.5 mm		1.04.403	1.04.405	1.04.407	1.04.409

Abutment screw, 4-lobe, titanium alloy



Length	PF 3.5	PF 4.0	PF 4.5	PF 5.0	PF 6.0
5.8 mm	4.03.500				
7.2 mm				4.03.501	
10.2 mm				4.03.502	



The milling abutments for CAD/CAM type II are compatible with Medentika® PreFace abutment holders, which are available for a large number of milling machines. You can find an overview of compatible milling machines at: www.thommenmedical.com.

 **Important** Thommen Medical provides the corresponding CAD libraries. You can find an overview at: www.thommenmedical.com.

SPI®VARIOflex

for cemented and screw-retained restorations

www.ifu-tm.com/THM61119

 Rotation locked
 Rotation unlocked

PF 3.5

PF 4.0

PF 4.5

PF 5.0

PF 6.0



Important Do not use abutments designed for single crowns with screw-retained bridge constructions, as axial divergences cannot be bridged.

VARIOflex abutment set for crown, titanium/POM

Height

12.0 mm

1.04.830

1.04.831

1.04.832

1.04.833

1.04.834



Set contents:

- 1 abutment
- 1 abutment screw
- 1 burn-out cap

VARIOflex abutment set for bridge, titanium/POM

Height

12.0 mm

1.04.835

1.04.836

1.04.837

1.04.838

1.04.839



Set contents:

- 1 abutment
- 1 abutment screw
- 1 burn-out cap

VARIOflex burn-out plastic cap, POM

Height

11.5 mm

2.03.840

2.03.841

2.03.842

2.03.843

2.03.844



Laboratory cylindrical pin, PTFE, 5 per pack (Q5)

Length

70.0 mm

2.03.450 Q5

2.03.451 Q5





Important Thommen Medical provides the corresponding CAD libraries. You can find an overview at: www.thommenmedical.com.

SPI®VARIOmulti

for screw-retained restorations

www.ifu-tm.com/THM61118

 Rotation locked
 Rotation unlocked

PF 3.5
PF 4.0
PF 4.5
PF 5.0
PF 6.0

VARIOmulti abutment, with handle, titanium

	Height (H)	Shoulder height (h)					
	3.0 mm	0.8 mm	4.03.600	4.03.601	4.03.602	4.03.603	
	3.7 mm	1.5 mm					4.03.604
	4.2 mm	2.0 mm	4.03.605	4.03.606	4.03.607	4.03.608	
	5.2 mm	3.0 mm	4.03.610	4.03.611	4.03.612	4.03.613	





VARIOmulti abutment, angled, titanium

	Angle	Height (H)	Shoulder height (h)					
	17°	4.3 mm	2.7 mm	4.03.680	4.03.681	4.03.682	4.03.683	4.03.684
	30°	4.4 mm	3.3 mm	4.03.685	4.03.686	4.03.687	4.03.688	4.03.689

Abutment screw is not included in delivery. Always use new abutment screws for the final insertion of abutments.

Abutment screw, 4-lobe, titanium alloy



	Length				
	5.8 mm	4.03.500			
	7.2 mm			4.03.501	
	10.2 mm			4.03.502	

Occlusal screw, 4-lobe, titanium alloy

	Length	
	3.5 mm	4.03.507

Bone contouring instrument+, reusable, stainless steel

	Length				
	29.0 mm	3.03.670	3.03.672	3.03.674	3.03.676
	For angled VARIOmulti abutment.				

-  Rotation locked
-  Rotation unlocked

 **VARIOfulti protective cap**, titanium



Ø	Height	
5.3 mm	4.5 mm	4.03.801

 **VARIOfulti temporary cap**, incl. fabrication screw, titanium/stainless steel

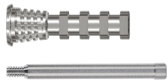

Ø	Height	
5.2 mm	15.0 mm	3.03.804

Fabrication screw for VARIOfulti temporary cap, 4-lobe, stainless steel,
4 per pack (Q4)



Length	
19.3 mm	3.03.598 Q4

 **VARIOfulti impression coping***, titanium



Ø	Height	
5.3 mm	18.0 mm	3.04.805

* Use the yellow screws for impression copings PF 3.5 (art. nos. 3.03.572, 3.03.573, 3.03.574, 3.03.580) to attach the VARIOfulti impression copings (see page 17).

 **VARIOfulti analog**, stainless steel



Ø	Height	
4.8 mm	21.2 mm	3.03.800

VARIOfulti analog for CAD/CAM, titanium





Ø	Length	
4.8 mm	13.2 mm	3.03.083

VARIOfulti analogs for CAD/CAM are used for 3D-printed models.

Insertion device for VARIOfulti analog for CAD/CAM, stainless steel



Length	
35.8 mm	3.03.157

-  Rotation locked
-  Rotation unlocked

 **VARIOmultip scan abutment**, titanium, surface treated, 4-lobe



Ø	Height	
4.5 mm	8.0 mm	3.03.780

 **VARIOmultip scan abutment, short**, titanium, surface treated, 4-lobe



Ø	Height	
5.0 mm	5.0 mm	3.03.781

No additional screws are necessary for the attachment of VARIOmultip scan abutments. The VARIOmultip scan abutments should be used as follows:

- Laboratory scan: long scan abutment (3.03.780)
- Intraoral scan with neighboring teeth: long scan abutment (3.03.780)
- Intraoral scan without neighboring teeth: short scan abutment (3.03.781), as long as the laser marking projects above the gingiva.

VARIOmultip titanium base for CAD/CAM, incl. occlusal screw, titanium/titanium alloy



Ø	Height	
4.8 mm	4.5 mm	1.04.850

VARIOmultip titanium base for CAD/CAM, customizable, incl. occlusal screw, titanium/titanium alloy



Ø	Height	
4.8 mm	9.0 mm	1.04.851

 **VARIOmultip gold cap**, incl. burn-out cylinder, NOA/burn-out plastic



Ø	Height	
4.8 mm	4.2/13.5 mm	2.03.600

 **VARIOmultip burn-out cap**, plastic, 2 per pack (Q2)



Ø	Height	
4.8 mm	13.5 mm	2.03.601 Q2

Positioning handle for angled VARIO and VARIOmulti abutments, stainless steel



Ø	Length	
4.0 mm	25.0 mm	3.03.521

VARIO/VARIOmulti reamer for base *, tungsten carbide



Length	
16.0 mm	3.03.420

* The VARIO reamer for base (art. no. 3.03.420) can also be used for processing the VARIOmulti gold cap (art. no. 2.03.600). For correct reworking of the base, use the VARIOmulti reamer for base with the associated VARIO guide pin (art. no. 3.03.424).

VARIO guide pin for VARIOmulti reamer, stainless steel



Length	
15.0 mm	3.03.424

Gauge for VARIO and VARIOmulti reamers for screw channel, for laboratory use, stainless steel



3.03.430

For correct reworking of the screw channel, use the VARIO (art. nos. 3.03.435, 3.03.436) and VARIOmulti (art. no. 3.03.437) reamer for screw channel.

VARIOmulti reamer for screw channel, tungsten carbide, stainless steel



Length	
40.0 mm	3.03.437

For correct reworking of the screw seat, use the VARIOmulti reamer for screw channel with the associated gauge (art. no. 3.03.430). A MONO insertion device (art. nos. 3.03.162, 3.03.163) is also required when using the reamer.

MONO insertion device, stainless steel/PEEK



Length	short*	long
	15.4 mm	25.8 mm
	3.03.162	3.03.163

* All latch-type instruments can be utilized with the MONO insertion device, short (art. no. 3.03.162).

SPI®VARIO

for screw-retained restorations

www.ifu-tm.com/THM61134, www.ifu-tm.com/THM61136

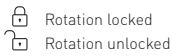

Rotation locked
Rotation unlocked

PF 3.5

PF 4.0

PF 4.5

PF 5.0

PF 6.0



Important Do not use abutments designed for single crowns with screw-retained bridge constructions, as axial divergences cannot be bridged.

VARIO gold abutment for crown, NOA/burn-out plastic



Height (H)	Cone (h)
12.7 mm	3.5 mm

2.03.410

2.03.414

2.03.411

2.03.412

2.03.413

Abutment screw is not included in delivery. Always use new abutment screws for the final insertion of abutments.

VARIO gold abutment for bridge, NOA/burn-out plastic



Height (H)	Cone (h)
12.7 mm	3.5 mm

2.03.400

2.03.404

2.03.401

2.03.402

2.03.403

Abutment screw is not included in delivery. Always use new abutment screws for the final insertion of abutments.

Abutment screw, 4-lobe, titanium alloy



Length
5.8 mm
7.2 mm
10.2 mm

4.03.500

4.03.501

4.03.502

VARIO abutment 17° set

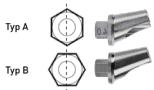

Height	Shoulder height
--------	-----------------

5.6 mm 0.5 mm

Type A 1.03.160

1.03.161

1.03.162

1.03.163

Type B 1.03.180

1.03.181

1.03.182

1.03.183



Set contents:

- 1 VARIO abutment 17° (titanium)
- 1 VARIO 17° gold screw seat
- 1 occlusal screw
- 1 abutment screw

VARIO abutments 17° have a Type A (0°) or B (30°) hexagon. They can therefore be aligned in 30° increments.

VARIO 17° gold screw seat, NOA/burn-out plastic (fits all platform sizes)



Height	∅
2.0/11.3 mm	2.9 mm

2.03.610

Occlusal screw, 4-lobe, titanium alloy



Length
3.5 mm

4.03.507

PF 3.5

PF 4.0

PF 4.5

PF 5.0

PF 6.0

Positioning handle for angled VARIO and VARIOmulti abutments, stainless steel

Length	∅	
25.0 mm	4.0 mm	3.03.521

VARIO/VARIOmulti reamer for base *, tungsten carbide

Length		
16.0 mm	3.03.420	3.03.421

* The VARIO reamer for base [art. no. 3.03.420] can also be used for processing the VARIOmulti gold cap [art. no. 2.03.600]. For correct reworking of the base, use the VARIOmulti reamer for base with the associated VARIO guide pin [art. no. 3.03.424].

VARIO guide pin for VARIO reamer, stainless steel

Length			
12.5 mm		3.03.425	3.03.423
15.0 mm	3.03.424		

**Gauge for VARIO and VARIOmulti reamers for screw channel**, for laboratory use, stainless steel**3.03.430**

For correct reworking of the screw channel, use the VARIO [art. nos. 3.03.435, 3.03.436] and VARIOmulti [art. no. 3.03.437] reamer for screw channel.

VARIO reamer for screw channel, tungsten carbide, stainless steel

Length		
44.0 mm	3.03.435	3.03.436

For correct reworking of the screw seat, use the VARIOmulti reamer for screw channel [art. No. 3.03.435] with the associated gauge [art. no. 3.03.430]. A MONO insertion device [art. nos. 3.03.162, 3.03.163] is also required when using the reamer.

MONO insertion device, stainless steel/PEEK



	short*	long
Length	15.4 mm	25.8 mm
	3.03.162	3.03.163

* All latch-type instruments can be utilized with the MONO insertion device, short [art. no. 3.03.162].

SPI®EASY

for cemented restorations

www.ifu-tm.com/THM61115

 Rotation locked
 Rotation unlocked

PF 3.5	PF 4.0	PF 4.5	PF 5.0	PF 6.0
--------	--------	--------	--------	--------

EASY abutment set, titanium

Collar	Cone	Height	PF 3.5	PF 4.0	PF 4.5	PF 5.0	PF 6.0
short 0.5 mm	4.0 mm	4.5 mm	1.04.700	1.04.708	1.04.701	1.04.702	1.04.703
short 0.5 mm	6.0 mm	6.5 mm	1.04.704	1.04.709	1.04.705	1.04.706	1.04.707
long 2.0 mm	4.0 mm	6.0 mm	1.04.710	1.04.718	1.04.711	1.04.712	1.04.713
long 2.0 mm	6.0 mm	8.0 mm	1.04.714	1.04.719	1.04.715	1.04.716	1.04.717
extra long 4.0 mm	6.0 mm	10.0 mm	1.04.734	1.04.739	1.04.735	1.04.736	











Set contents:

- 1 EASY abutment
- 1 abutment screw
- 1 EASY impression coping
- 1 EASY analog
- 1 EASY temporary cap
- 1 EASY burn-out cap, for crowns
- 1 EASY burn-out cap, for bridges



EASY abutments are also available both individually and in sets with separate article numbers for all platforms. Angled EASY abutments and EASY Abutments e.p. (emergency profile) can only be ordered individually.



EASY abutment, titanium

Collar	Cone	Height	PF 3.5	PF 4.0	PF 4.5	PF 5.0	PF 6.0
 short 0.5 mm	4.0 mm	4.5 mm	4.03.700	4.03.708	4.03.701	4.03.702	4.03.703
 short 0.5 mm	6.0 mm	6.5 mm	4.03.704	4.03.709	4.03.705	4.03.706	4.03.707
 long 2.0 mm	4.0 mm	6.0 mm	4.03.710	4.03.718	4.03.711	4.03.712	4.03.713
 long 2.0 mm	6.0 mm	8.0 mm	4.03.714	4.03.719	4.03.715	4.03.716	4.03.717
 extra long 4.0 mm	6.0 mm	10.0 mm	4.03.734	4.03.739	4.03.735	4.03.736	
 20°/short 0.5 mm		6.5 mm	4.03.010	4.03.018	4.03.011	4.03.012	4.03.013
 20°/long 3.0 mm		8.0 mm	4.03.014				
 20°/long 3.0 mm		9.0 mm		4.03.019	4.03.015	4.03.016	4.03.017

Abutment screw is not included in delivery. Always use new abutment screws for the final insertion of abutments.

Abutment screw, 4-lobe, titanium alloy

Length	PF 3.5	PF 4.0	PF 4.5	PF 5.0	PF 6.0
 5.8 mm	4.03.500				
 7.2 mm				4.03.501	
 10.2 mm				4.03.502	

 Rotation locked
 Rotation unlocked

PF 3.5

PF 4.0

PF 4.5

PF 5.0

PF 6.0

 **EASY impression coping, plastic**



Height	Cone	PF 3.5	PF 4.0	PF 4.5	PF 5.0	PF 6.0
9.5 mm	4.0 mm	2.03.700	2.03.708	2.03.701	2.03.702	2.03.703
11.5 mm	6.0 mm	2.03.704	2.03.709	2.03.705	2.03.706	2.03.707

Not suitable for EASY abutment 20°.

 **EASY temporary cap, PMMA-based plastic**



Height	Cone	PF 3.5	PF 4.0	PF 4.5	PF 5.0	PF 6.0
5.0 mm	4.0 mm	2.03.740	2.03.748	2.03.741	2.03.742	2.03.743
7.0 mm	6.0 mm	2.03.744	2.03.749	2.03.745	2.03.746	2.03.747

 **EASY analog, stainless steel**



Height	Cone	PF 3.5	PF 4.0	PF 4.5	PF 5.0	PF 6.0
14.0 mm	4.0 mm	3.03.700	3.03.708	3.03.701	3.03.702	3.03.703
16.0 mm	6.0 mm	3.03.704	3.03.709	3.03.705	3.03.706	3.03.707

 **EASY burn-out cap, for crown, burn-out plastic**



Height	Cone	PF 3.5	PF 4.0	PF 4.5	PF 5.0	PF 6.0
4.7 mm	4.0 mm	2.03.720	2.03.728	2.03.721	2.03.722	2.03.723
6.7 mm	6.0 mm	2.03.724	2.03.729	2.03.725	2.03.726	2.03.727



 **EASY burn-out cap, for bridge, burn-out plastic**



Height	Cone	PF 3.5	PF 4.0	PF 4.5	PF 5.0	PF 6.0
4.7 mm	4.0 mm	2.03.730	2.03.738	2.03.731	2.03.732	2.03.733
6.7 mm	6.0 mm	2.03.734	2.03.739	2.03.735	2.03.736	2.03.737

SPI®EASY emergence profile

for cemented restorations

 Rotation locked
 Rotation unlocked

PF 4.0

PF 4.5

PF 5.0

EASY abutment e.p., titanium

Collar height for all EASY abutments e.p.: 3.0 mm





PF / PF e.p.	Cone (h)	Height (H)			
4.0 / 4.5	4.0 mm	7.0 mm	4.03.728		
4.0 / 4.5	6.0 mm	9.0 mm	4.03.729		
4.5 / 5.0	4.0 mm	7.0 mm		4.03.721	
4.5 / 5.0	6.0 mm	9.0 mm		4.03.725	
5.0 / 6.0	4.0 mm	7.0 mm			4.03.722
5.0 / 6.0	6.0 mm	9.0 mm			4.03.726

Abutment screw is not included in delivery. Always use new abutment screws for the final insertion of abutments.

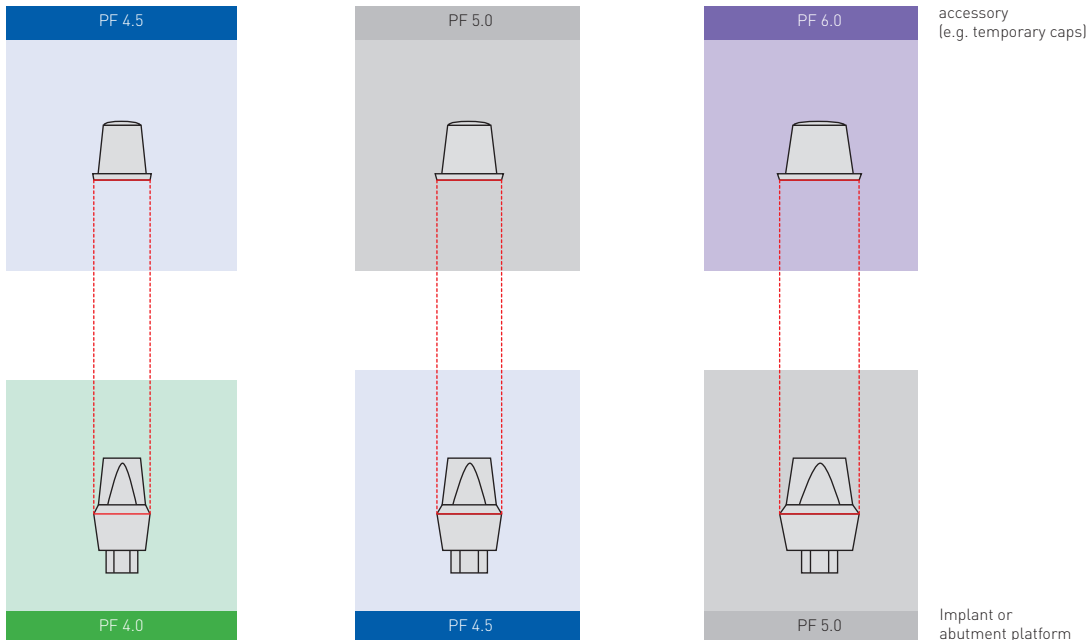
 **Important** If using EASY abutments emergence profile (e.p.) always use prefabricated EASY accessory components (impression copings, temporary caps, analogs, burn-out caps) of the **next larger platform diameter**.



 Rotation locked
 Rotation unlocked

PF 4.5

PF 5.0

PF 6.0



 **EASY impression coping, plastic**

Height	Cone (h)			
9.5 mm	4.0 mm	2.03.701	2.03.702	2.03.703
11.5 mm	6.0 mm	2.03.705	2.03.706	2.03.707

Not suitable for EASY abutment 20°.



 **EASY temporary cap, PMMA-based plastic**

Height	Cone (h)			
5.0 mm	4.0 mm	2.03.741	2.03.742	2.03.743
7.0 mm	6.0 mm	2.03.745	2.03.746	2.03.747



 **EASY analog, stainless steel**

Height	Cone (h)			
14.0 mm	4.0 mm	3.03.701	3.03.702	3.03.703
16.0 mm	6.0 mm	3.03.705	3.03.706	3.03.707



 **EASY burn-out cap, for crown, burn-out plastic**

Height	Cone (h)			
4.7 mm	4.0 mm	2.03.721	2.03.722	2.03.723
6.7 mm	6.0 mm	2.03.725	2.03.726	2.03.727



 **EASY burn-out cap, for bridge, burn-out plastic**

Height	Cone (h)			
4.7 mm	4.0 mm	2.03.731	2.03.732	2.03.733
6.7 mm	6.0 mm	2.03.735	2.03.736	2.03.737





Abutment screw, 4-lobe, titanium alloy

Length	
7.2 mm	4.03.501
10.2 mm	4.03.502

SPI[®]ART

for esthetic restorations, cemented and screw-retained

www.ifu-tm.com/THM61135

 Rotation locked
 Rotation unlocked

PF 3.5

PF 4.0

PF 4.5

PF 5.0



 **ART grinding cylinder abutment**, incl. abutment screw, zirconium/titanium alloy

Height

12.0 mm

1.03.649

1.03.650

1.03.651

1.03.652



 **ART abutment**, incl. abutment screw, zirconium/titanium alloy

PF / PF e.p. Height (H) Cone (h)

3.5 / 4.5 9.0 mm 6.0 mm

1.03.623

4.0 / 4.5 9.0 mm 6.0 mm

1.03.624

4.5 / 5.0 9.0 mm 6.0 mm

1.03.625

5.0 / 6.0 9.0 mm 6.0 mm

1.03.626

 **Important** When using ART abutments always use prefabricated EASY accessory components (impression copings, temporary caps, analogs) of the **next larger platform diameter**.

An exception is the platform 3.5, which has a prosthetic base (e.p.) of 4.5.

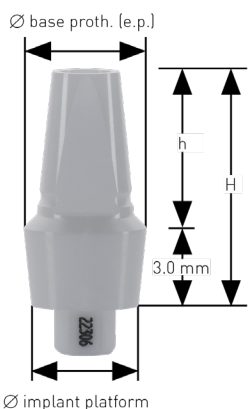
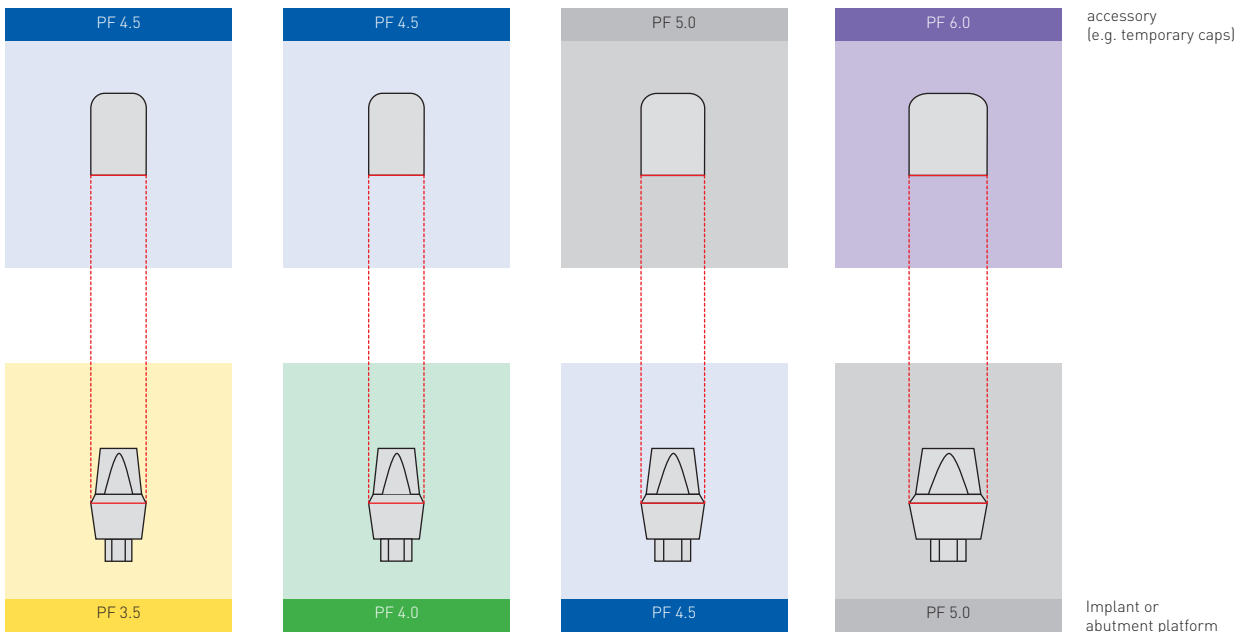

🔒 Rotation locked
🔓 Rotation unlocked

PF 4.5

PF 5.0

PF 6.0



🔒 **EASY impression coping**, plastic

Height	Cone (h)
11.5 mm	6.0 mm

2.03.705

2.03.706

2.03.707



🔒 **EASY temporary cap**, PMMA-based plastic

Height	Cone (h)
7.0 mm	6.0 mm

2.03.745

2.03.746

2.03.747



🔒 **EASY analog**, stainless steel

Height	Cone (h)
16.0 mm	6.0 mm

3.03.705



3.03.706

3.03.707

SPI[®]RETAIN

for hybrid removable dentures

www.ifu-tm.com/THM61128

 Rotation locked
 Rotation unlocked

PF 3.5

PF 4.0

PF 4.5

PF 5.0

PF 6.0

Retentive anchor, titanium



Height

1.8 mm	short		4.03.048	4.03.040	4.03.042	
3.0 mm	long		4.03.049	4.03.041	4.03.043	

Thommen Medical retentive anchors have a spherical diameter of 2.25 mm and are compatible with all matrices of this geometry (e.g. Dalbo[®]-PLUS, Tima[®], Ecco[®], Pro-Snap, etc.).

Retentive anchor analog, titanium



Length

13.0 mm	3.03.033
---------	----------

Thommen Medical retentive anchors have a spherical diameter of 2.25 mm and are compatible with all matrices of this geometry (e.g. Dalbo[®]-PLUS, Tima[®], Ecco[®], Pro-Snap[®], etc.).

MONO insertion device for retentive anchor, stainless steel/PEEK



Length	∅
26.0 mm	8.5 mm

3.03.169

Milling abutment, titanium



Height

11.0 mm	4.03.420				
12.0 mm		4.03.428	4.03.421	4.03.422	4.03.423

Abutment screw is not included in delivery. Always use new abutment screws for the final insertion of abutments.

Abutment screw, 4-lobe, titanium alloy



Length

5.8 mm	4.03.500			
7.2 mm			4.03.501	
10.2 mm			4.03.502	

Rotation locked
Rotation unlocked

PF 3.5

PF 4.0

PF 4.5

PF 5.0

PF 6.0

 **Bar abutment, titanium**



Height

5.5 mm

4.03.380

4.03.388

4.03.381

4.03.382

Abutment screw is not included in delivery. Always use new abutment screws for the final insertion of abutments. Abutment screw 4.03.502 is not compatible with bar abutment.

 **Gold cap for bar, gold alloy**



Height

4.7 mm

2.03.335

 **Titanium coping for bar, titanium**



Height

4.7 mm

4.03.070

Occlusal screw for bar, 4-lobe, titanium alloy



Length

4.3 mm

4.03.506

 **Solder pin for bar, stainless steel**



Length

13.5 mm

3.03.151

 **Impression coping for bar, aluminum, anodized/plastic**



Height

5.0 mm

∅

6.0 mm

3.03.101

 **Bar analog, titanium**



Length

21.5 mm

∅

4.0 mm

3.03.105

ZEST® LOCATOR®

implant attachment system

www.zestdent.com

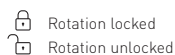

PF 3.5

PF 4.0

PF 4.5

PF 5.0

PF 6.0

LOCATOR® abutment, titanium alloy

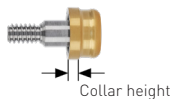

Collar height

0.73 mm	8875				
1.0 mm		8461	8786	8792	8881
2.0 mm	8876	8462	8787	8793	8882
3.0 mm	8877	8463	8788	8794	8883
4.0 mm	8878	8464	8789	8795	8884
5.0 mm	8879*	8465	8790	8796	
6.0 mm	8880*	8466	8791	8797	

LOCATOR® abutment and collar for VARIOmulti, 2 per pack

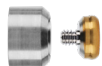

Collar height

3.0 mm	8909-2
--------	---------------

LOCATOR® laboratory set, pack contains 2 sets, titanium/nylon



8519-2

Contents per set:

- 1 LOCATOR® cap with male processing, black (8515)
- 1 LOCATOR® block-out spacer (8514)
- 1 LOCATOR® male replacement, clear (8524)
- 1 LOCATOR® male replacement, pink (8527)
- 1 LOCATOR® male replacement, blue (8529)
- 1 LOCATOR® matrix housing

LOCATOR® laboratory set, for extended range, pack contains 2 sets, titanium/nylon



8540-2

Contents per set:

- 1 LOCATOR® cap with male processing, black (85152)
- 1 LOCATOR® block-out spacer (8514)
- 1 LOCATOR® male replacement, green (8547)
- 1 LOCATOR® male replacement, orange (8915)
- 1 LOCATOR® male replacement, red (8548)
- 1 LOCATOR® matrix housing

LOCATOR® male replacement, 4 per pack, nylon





Retention value	Color	
2268 g	clear	8524
light	pink	8527
extra light	blue	8529



LOCATOR® male replacement, for extended range, 4 per pack, nylon





Retention value	Color	
1361–1841 g	green	8547
light	orange	8915
extra light	red	8548

-  Rotation locked
-  Rotation unlocked

	LOCATOR® core tool , stainless steel	8393
---	---	-------------

	 LOCATOR® impression coping , 4 per pack, aluminum/LDPE	8505
---	---	-------------

	 LOCATOR® analog , 4 per pack, aluminum	
	∅	
	4.0 mm (preferably used with PF 3.5, 4.0 and 4.5 mm)	8530
	5.0 mm (preferably used with PF 5.0 and 6.0 mm)	8516

	LOCATOR® parallel posts , 4 per pack, LDPE	8517
---	---	-------------

	LOCATOR® angle measurement guide , stainless steel	
	Width Height	
	50.0 mm 15.0 mm	9530

	LOCATOR® male processing , black, 20 per pack, nylon	8515-20
---	---	----------------

	LOCATOR® block-out spacer , 20 per pack, Teflon®	8514
---	---	-------------

	LOCATOR® insert for hand piece and for short MONO insertion device , Stainless steel	
	Length	
	23.0 mm	8913
	29.0 mm	8914

Instruments

for mechanical operation

www.ifu-tm.com/THM61141

PF 3.5

PF 4.0

PF 4.5

PF 5.0

PF 6.0

Adapter for hand piece, one-piece, stainless steel



Length

24.0 mm

3.03.248

3.03.251

3.03.241

Adapter for hand piece, stainless steel



Length

18.0 mm

3.03.240



28.0 mm

3.03.249

Screwdriver for hand piece, 4-lobe, stainless steel



Length

extra short

short

long

extra long

17.0 mm

22.0 mm

28.0 mm

38.0 mm

Shaft length

4.0 mm

8.5 mm

14.5 mm

24.5 mm

3.03.500

3.03.501

3.03.502

3.03.503

All latch-type instruments can be utilized with the MONO insertion device, short (art. no. 3.03.162), and with the MONO torque ratchet (art. no. 3.03.160).

Instruments

for manual operation

www.ifu-tm.com/THM61141

MONO torque ratchet, titanium alloy



Length

110.0 mm

3.03.160

The MONO torque ratchet ensures a precise control of the torque applied. Please see the overview of torque values on page 75.

MONO guide key, stainless steel



Length

94.7 mm

3.03.203

MONO circlip, viton, 2 per pack (Q2)



2.03.170 Q2



MONO insertion device, stainless steel/PEEK

	short*	long
Length	15.4 mm	25.8 mm
	3.03.162	3.03.163

* All latch-type instruments can be utilized with the MONO insertion device, short (art. no. 3.03.162), and the MONO torque ratchet (art. no. 3.03.160).



MONO screw driver, 4-lobe, stainless steel/PEEK

	extra short*	short	long
Length	14.5 mm	22.2 mm	28.2 mm
Shaft length	5.1 mm	10.3 mm	16.3 mm
	3.03.165	3.03.166	3.03.167

* The MONO screwdriver extra short is made of stainless steel only, without PEEK finger rest.



Handle for dental laboratory, brass/steel

Length	120.0 mm
	3.03.250



Insertion device for implant analog for CAD/CAM, stainless steel



Length	35.0 mm	3.03.158			
	35.0 mm		3.03.159		

Insertion device for VARIOmulti analog for CAD/CAM, stainless steel



Length	35.8 mm
	3.03.157

Instruments for guided surgery

www.ifu-tm.com/THM61144

Initial drill, guided, stainless steel



Length	Ø 2.0 mm
28.5 mm L 4.0	3.04.110

VECTOdrill™ pilot drill and twist drill, guided, stainless steel



Diameter	Implant length	L 6.5	L 8.0	L 9.5	L 11.0	L 12.5
	Drill length	31.5 mm	33.0 mm	34.5 mm	36.0 mm	37.5 mm
Ø 2.0 mm		3.04.111	3.04.112	3.04.113	3.04.114	3.04.115
Ø 2.8 mm		3.04.121	3.04.122	3.04.123	3.04.124	3.04.125
Ø 3.5 mm		3.04.131	3.04.132	3.04.133	3.04.134	3.04.135

Profile drill, guided, stainless steel



PF	Implant type	CONTACT MC	CONTACT RC	ELEMENT MC
	Drill length	34.0 mm	32.5 mm	30.5 mm
PF 3.5		3.04.171	3.04.161	3.04.151
PF 4.0		3.04.172	3.04.162	3.04.152
PF 4.5		3.04.173	3.04.163	3.04.153

Adapter, guided, stainless steel



Length	
25.5 mm	3.04.090

Guiding sleeve, stainless steel



Length	Ø 4.8 mm
5.0 mm	3.04.080 Q4

Seating instrument for guiding sleeve, stainless steel



Length	Ø 4.8 mm
28.5 mm	3.04.100

Guiding sleeve for VECTOdrill™ pilot drill, stainless steel, 4 per pack (Q4)



Length	Internal Ø	
6.0 mm	2.0 mm	3.03.141 Q4

The guiding sleeve for **VECTOdrill™ pilot drill** can only be used with the **VECTOdrill™ pilot drill**.

Adapter for hand piece, one-piece, stainless steel



Length			
24.0 mm	3.03.248	3.03.251	3.03.241

Adapter for hand piece can be optionally be used for implant Insertion for non-guided surgery. The one-piece adapter for hand piece engages directly into the implant hexagon.

You can find standard instruments for guided surgery at: www.ifu-tm.com/THM61144.

Cassettes

www.ifu-tm.com/THM61131



Surgical cassette, for mechanical cleaning, stainless steel/aluminum

Length × width × height
276.0 × 176.0 × 59.5 mm

1.03.030

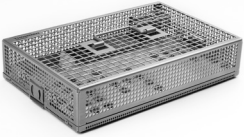

Surgical cassette for guided surgery, PF 3.5 – PF 4.5 / L6.5 - L12.5 mm, for mechanical cleaning,

Length × width × height
276.0 × 176.0 × 59.5 mm

1.04.020



consisting of 2 instrument holders, size S

8.03.090 Q2

consisting of 1 instrument holder, size M

8.03.091

Size S is compatible with surgical cassette for guided surgery 1.04.020 and sizes S and M are compatible with surgical cassette 1.03.030.



Container for surgical cassette, incl. identification plate Thommen Medical, aluminum alloy

Length × width × height
312.0 × 189.0 × 83.0 mm

ER510.080E

Single-use paper filter, 100 per pack

Length × width
118.0 × 235.0 mm

ER802.000N



Permanent filter, 1200 sterilization cycles, PTFE

Length × width
95.0 × 215.0 mm

ER802.020

ER802.000N and ER802.020 are compatible with Container ER510.080E.
Not available in the USA.



Prosthetic cassette, incl. screw organizer, thermoplastic, sterilizable

Length × width × height
190.0 × 140.0 × 58.0 mm

1.03.022



Screw organizer for prosthetic cassette, plastic, sterilizable

Length × width × height
56.0 × 47.0 × 33.5 mm

8.03.019



Ultrasonic cleaning cassette, plastic

Length × width × height
160.0 × 72.0 × 28.0 mm

8.03.059



Silicone holder set, silicone, for surgical and prosthetic cassettes,
consisting of four different sizes, 2 pieces each, (grey)

1.03.056

Suitable for items 1.03.022 and 1.03.016.

Explantation instruments

www.ifu-tm.com/THM61152

PF 3.5

PF 4.0

PF 4.5

PF 5.0

PF 6.0

Explantation drill for ELEMENT implants, stainless steel

		Length				
		External Ø	4.3 mm	5.0 mm	6.3 mm	7.3 mm
		internal Ø	3.8 mm	4.5 mm	5.3 mm	6.3 mm
	31.0 mm* short		3.03.303	3.03.304	3.03.305	3.03.306
	37.0 mm long		3.03.300	3.03.301	3.03.302	

Explantation drill for CONTACT implants, stainless steel

		Length			
		External Ø	4.3 mm	5.0 mm	6.3 mm
		internal Ø	3.8 mm	4.5 mm	5.3 mm
	31.0 mm* short		3.03.303	3.03.304	3.03.305
	37.0 mm long		3.03.300	3.03.301	3.03.302

Guiding cylinder for ELEMENT and CONTACT implants, stainless steel

		Length					
		External Ø	3.7 mm	4.4 mm	4.4 mm	5.2 mm	6.2 mm
	3.0 mm ELEMENT		3.03.308	3.03.307	3.03.309	3.03.310	3.03.313
	3.0 mm CONTACT		3.03.308	3.03.307	3.03.309	3.03.310	

Use abutment screws art. nos. 4.03.500 (PF B 3.5 mm) and 4.03.501 (PF 4.0–6.0) to attach guiding cylinders on the implant. Abutment screw is not included in the delivery.

 *** Important** Only use explantation drills 31.0 mm in length for the following implant lengths:

ELEMENT	6.5–12.5 mm
CONTACT	6.5–12.5 mm
CONTACT PF 6.0	9.5–11.0 mm

 **Important** Explantation drills for ONETIME and DIRECT Implants are still available. To purchase, please contact your country representative.

Index by article numbers

1.03	Prosthetic cassette, incl. screw organizer	
1.03.022	length 190.0 mm, width 140.0 mm, height 58.0 mm	57
	Surgical cassette, for mechanical cleaning	
1.03.030	length 274.8 mm, width 176.0 mm, height 63.6 mm	57
1.03.056	Silicone holder set, for surgical and prosthetic cassettes	57
	VARIO abutment 17° set	
1.03.160	Type A, PF 3.5, height 5.6 mm, shoulder height 0.5 mm	41
1.03.161	Type A, PF 4.0, height 5.6 mm, shoulder height 0.5 mm	41
1.03.162	Type A, PF 4.5, height 5.6 mm, shoulder height 0.5 mm	41
1.03.163	Type A, PF 5.0, height 5.6 mm, shoulder height 0.5 mm	41
1.03.180	Type B, PF 3.5, height 5.6 mm, shoulder height 0.5 mm	41
1.03.181	Type B, PF 4.0, height 5.6 mm, shoulder height 0.5 mm	41
1.03.182	Type B, PF 4.5, height 5.6 mm, shoulder height 0.5 mm	41
1.03.183	Type B, PF 5.0, height 5.6 mm, shoulder height 0.5 mm	41
	ART abutment, incl. abutment screw	
1.03.623	PF 3.5/4.5, cone 6.0 mm, height 9.0 mm	47
1.03.624	PF 4.0/4.5, cone 6.0 mm, height 9.0 mm	47
1.03.625	PF 4.5/5.0, cone 6.0 mm, height 9.0 mm	47
1.03.626	PF 5.0/6.0, cone 6.0 mm, height 9.0 mm	47
	ART grinding cylinder-abutment, incl. abutment screw	
1.03.649	PF 3.5, height 12.0 mm	47
1.03.650	PF 4.0, height 12.0 mm	47
1.03.651	PF 4.5, height 12.0 mm	47
1.03.652	PF 5.0, height 12.0 mm	47

1.04	Surgical cassette for guided surgery, for mechanical cleaning	57
	VARIOtemp abutment set for crowns	
1.04.080	PF 3.5, height 12.0 mm	32
1.04.081	PF 4.0, height 12.0 mm	32
1.04.082	PF 4.5, height 12.0 mm	32
1.04.083	PF 5.0, height 12.0 mm	32
1.04.084	PF 6.0, height 12.0 mm	32
	VARIOtemp abutment set for bridges	
1.04.085	PF 3.5, height 12.0 mm	32
1.04.086	PF 4.0, height 12.0 mm	32
1.04.087	PF 4.5, height 12.0 mm	32
1.04.088	PF 5.0, height 12.0 mm	32
1.04.089	PF 6.0, height 12.0 mm	32
1.04.138	VARIOunite abutment PF 3.0 for crown	11
	Milling abutment for CAD/CAM Type II, incl. abutment screw	
1.04.401	PF 3.5, length 15.0 mm, Ø 8.0 mm	35
1.04.403	PF 4.0, length 15.0 mm, Ø 11.5 mm	35
1.04.405	PF 4.5, length 15.0 mm, Ø 11.5 mm	35
1.04.407	PF 5.0, length 15.0 mm, Ø 11.5 mm	35
1.04.409	PF 6.0, length 15.0 mm, Ø 11.5 mm	35
	EASY abutment set, short	
1.04.700	PF 3.5, collar 0.5 mm, cone 4.0 mm, height 4.5 mm	43
1.04.701	PF 4.5, collar 0.5 mm, cone 4.0 mm, height 4.5 mm	43
1.04.702	PF 5.0, collar 0.5 mm, cone 4.0 mm, height 4.5 mm	43
1.04.703	PF 6.0, collar 0.5 mm, cone 4.0 mm, height 4.5 mm	43
1.04.704	PF 3.5, collar 0.5 mm, cone 6.0 mm, height 6.5 mm	43
1.04.705	PF 4.5, collar 0.5 mm, cone 6.0 mm, height 6.5 mm	43
1.04.706	PF 5.0, collar 0.5 mm, cone 6.0 mm, height 6.5 mm	43
1.04.707	PF 6.0, collar 0.5 mm, cone 6.0 mm, height 6.5 mm	43
1.04.708	PF 4.0, collar 0.5 mm, cone 4.0 mm, height 4.5 mm	43
1.04.709	PF 4.0, collar 0.5 mm, cone 6.0 mm, height 6.5 mm	43
	EASY abutment set, long	
1.04.710	PF 3.5, collar 2.0 mm, cone 4.0 mm, height 6.0 mm	43
1.04.711	PF 4.5, collar 2.0 mm, cone 4.0 mm, height 6.0 mm	43
1.04.712	PF 5.0, collar 2.0 mm, cone 4.0 mm, height 6.0 mm	43
1.04.713	PF 6.0, collar 2.0 mm, cone 4.0 mm, height 6.0 mm	43
1.04.714	PF 3.5, collar 2.0 mm, cone 6.0 mm, height 8.0 mm	43
1.04.715	PF 4.5, collar 2.0 mm, cone 6.0 mm, height 8.0 mm	43
1.04.716	PF 5.0, collar 2.0 mm, cone 6.0 mm, height 8.0 mm	43
1.04.717	PF 6.0, collar 2.0 mm, cone 6.0 mm, height 8.0 mm	43
1.04.718	PF 4.0, collar 2.0 mm, cone 4.0 mm, height 6.0 mm	43
1.04.719	PF 4.0, collar 2.0 mm, cone 6.0 mm, height 8.0 mm	43
	EASY abutment set, extra long	
1.04.734	PF 3.5, collar 4.0 mm, cone 6.0 mm, height 10.0 mm	43
1.04.735	PF 4.5, collar 4.0 mm, cone 6.0 mm, height 10.0 mm	43
1.04.736	PF 5.0, collar 4.0 mm, cone 6.0 mm, height 10.0 mm	43
1.04.739	PF 4.0, collar 4.0 mm, cone 6.0 mm, height 10.0 mm	43
	Titanium base with hexagon for CAD/CAM, incl. abutment screw	
1.04.750	PF 3.5, height 5.2 mm	33
1.04.751	PF 4.0, height 5.2 mm	33
1.04.752	PF 4.5, height 5.2 mm	33
1.04.753	PF 5.0, height 5.2 mm	33
1.04.754	PF 6.0, height 5.2 mm	33

	Titanium Base bridge for CAD/CAM, incl. abutment screw	
1.04.760	PF 3.5, height 5.2 mm	33
1.04.761	PF 4.0, height 5.2 mm	33
1.04.762	PF 4.5, height 5.2 mm	33
1.04.763	PF 5.0, height 5.2 mm	33
1.04.764	PF 6.0, height 5.2 mm	33
	VARIOflex abutment set for crown	
1.04.830	PF 3.5, height 12.0 mm	36
1.04.831	PF 4.0, height 12.0 mm	36
1.04.832	PF 4.5, height 12.0 mm	36
1.04.833	PF 5.0, height 12.0 mm	36
1.04.834	PF 6.0, height 12.0 mm	36
	VARIOflex abutment set for bridge	
1.04.835	PF 3.5, height 12.0 mm	36
1.04.836	PF 4.0, height 12.0 mm	36
1.04.837	PF 4.5, height 12.0 mm	36
1.04.838	PF 5.0, height 12.0 mm	36
1.04.839	PF 6.0, height 12.0 mm	36
	VARIOmulti titanium base for CAD/CAM, incl. occlusal screw, titanium/titanium alloy, Ø 4.8 mm, height 4.5 mm	39
1.04.850		
	VARIOmulti titanium base for CAD/CAM, customizable, incl. occlusal screw, titanium/titanium alloy, Ø 4.8 mm, height 9 mm	39
1.04.851		

2.03	2.03.170 Q2 MONO circlip [2 pieces]	54
2.03.335	Gold cap for bar, height 4.7 mm	50
	VARIO gold abutment for bridge	
2.03.400	PF 3.5, height 12.7 mm, cone 3.5 mm	41
2.03.401	PF 4.5, height 12.7 mm, cone 3.5 mm	41
2.03.402	PF 5.0, height 12.7 mm, cone 3.5 mm	41
2.03.403	PF 6.0, height 12.7 mm, cone 3.5 mm	41
2.03.404	PF 4.0, height 12.7 mm, cone 3.5 mm	41
	VARIO gold abutment for crown	
2.03.410	PF 3.5, height 12.7 mm, cone 3.5 mm	41
2.03.411	PF 4.5, height 12.7 mm, cone 3.5 mm	41
2.03.412	PF 5.0, height 12.7 mm, cone 3.5 mm	41
2.03.413	PF 6.0, height 12.7 mm, cone 3.5 mm	41
2.03.414	PF 4.0, height 12.7 mm, cone 3.5 mm	41
	Laboratory cylindrical pin [5 pieces]	
2.03.450 Q5	PF 3.5, length 70.0 mm	11,33,36
2.03.451 Q5	PF 4.0-6.0, length 70.0 mm	33,36
	VARIOmulti gold cap, incl. burn-out plastic cylinder, Ø 4.8 mm, height 4.2/13.5 mm	39
2.03.600		
	VARIOmulti burn-out cap [2 pieces] Ø 4.8 mm, height 13.5 mm	39
2.03.601 Q2		
	VARIO 17° gold screw seat [fits all platform sizes] Ø 2.9 mm, height 2.0/11.3 mm	41
2.03.610		
	EASY impression coping	
2.03.700	PF 3.5, cone 4.0 mm, height 9.5 mm	19,44
2.03.701	PF 4.5, cone 4.0 mm, height 9.5 mm	19,44,46
2.03.702	PF 5.0, cone 4.0 mm, height 9.5 mm	19,44,46
2.03.703	PF 6.0, cone 4.0 mm, height 9.5 mm	19,44,46
2.03.704	PF 3.5, cone 6.0 mm, height 11.5 mm	19,44
2.03.705	PF 4.5, cone 6.0 mm, height 11.5 mm	19,44,46,48
2.03.706	PF 5.0, cone 6.0 mm, height 11.5 mm	19,44,46,48
2.03.707	PF 6.0, cone 6.0 mm, height 11.5 mm	19,44,46,48
2.03.708	PF 4.0, cone 4.0 mm, height 9.5 mm	19,44
2.03.709	PF 4.0, cone 6.0 mm, height 11.5 mm	19,44
	EASY burn-out cap, for crown, burn-out plastic	
2.03.720	PF 3.5, cone 4.0 mm, height 4.7 mm	44
2.03.721	PF 4.5, cone 4.0 mm, height 4.7 mm	44,46
2.03.722	PF 5.0, cone 4.0 mm, height 4.7 mm	44,46
2.03.723	PF 6.0, cone 4.0 mm, height 4.7 mm	44,46
2.03.724	PF 3.5, cone 6.0 mm, height 6.7 mm	44
2.03.725	PF 4.5, cone 6.0 mm, height 6.7 mm	44,46
2.03.726	PF 5.0, cone 6.0 mm, height 6.7 mm	44,46
2.03.727	PF 6.0, cone 6.0 mm, height 6.7 mm	44,46
2.03.728	PF 4.0, cone 4.0 mm, height 4.7 mm	44
2.03.729	PF 4.0, cone 6.0 mm, height 6.7 mm	44
	EASY burn-out cap for bridge	
2.03.730	PF 3.5, cone 4.0 mm, height 4.7 mm	44
2.03.731	PF 4.5, cone 4.0 mm, height 4.7 mm	44,46
2.03.732	PF 5.0, cone 4.0 mm, height 4.7 mm	44,46
2.03.733	PF 6.0, cone 4.0 mm, height 4.7 mm	44,46
2.03.734	PF 3.5, cone 6.0 mm, height 6.7 mm	44
2.03.735	PF 4.5, cone 6.0 mm, height 6.7 mm	44,46
2.03.736	PF 5.0, cone 6.0 mm, height 6.7 mm	44,46
2.03.737	PF 6.0, cone 6.0 mm, height 6.7 mm	44,46
2.03.738	PF 4.0, cone 4.0 mm, height 4.7 mm	44
2.03.739	PF 4.0, cone 6.0 mm, height 6.7 mm	44

EASY temporary cap		
2.03.740	PF 3.5, cone 4.0 mm, height 5.0 mm	44
2.03.741	PF 4.5, cone 4.0 mm, height 5.0 mm	44,46
2.03.742	PF 5.0, cone 4.0 mm, height 5.0 mm	44,46
2.03.743	PF 6.0, cone 4.0 mm, height 5.0 mm	44,46
2.03.744	PF 3.5, cone 6.0 mm, height 7.0 mm	44
2.03.745	PF 4.5, cone 6.0 mm, height 7.0 mm	44,46,48
2.03.746	PF 5.0, cone 6.0 mm, height 7.0 mm	44,46,48
2.03.747	PF 6.0, cone 6.0 mm, height 7.0 mm	44,46,48
2.03.748	PF 4.0, cone 4.0 mm, height 5.0 mm	44
2.03.749	PF 4.0, cone 6.0 mm, height 7.0 mm	44
VARIOeco burn-out plastic cap, for titanium base		
2.03.790	PF 3.5, height 12.0 mm	33
2.03.791	PF 4.0, height 12.0 mm	33
2.03.792	PF 4.5, height 12.0 mm	33
2.03.793	PF 5.0, height 12.0 mm	33
2.03.794	PF 6.0, height 12.0 mm	33
VARIOflex burn-out plastic cap		
2.03.840	PF 3.5, height 11.5 mm	36
2.03.841	PF 4.0, height 11.5 mm	36
2.03.842	PF 4.5, height 11.5 mm	36
2.03.843	PF 5.0, height 11.5 mm	36
2.03.844	PF 6.0, height 11.5 mm	36
2.03.848	VARIOunite burn-out plastic cap PF 3.0,	11

3.03

Impression coping for open tray technique, single use, retentive, screw-retained, cylindrical		
3.03.010	PF 3.5, external Ø 3.8 mm, height 10.0 mm	17
3.03.011	PF 4.5, external Ø 4.8 mm, height 10.0 mm	17
3.03.012	PF 5.0, external Ø 5.3 mm, height 10.0 mm	17
3.03.013	PF 6.0, external Ø 6.3 mm, height 10.0 mm	17
Impression coping for closed tray technique, single use, repositionable, screw-retained, long		
3.03.014	PF 3.5, external Ø 3.9 mm, height 12.0 mm	16
3.03.015	PF 4.5, external Ø 5.5 mm, height 12.0 mm	16
3.03.016	PF 5.0, external Ø 6.0 mm, height 12.0 mm	16
3.03.017	PF 6.0, external Ø 7.0 mm, height 12.0 mm	16
Impression coping for open tray technique, single use, retentive, screw-retained, cylindrical		
3.03.018	PF 4.0, external Ø 4.3 mm, height 10.0 mm	17
Impression coping for closed tray technique, single use, repositionable, screw-retained, long		
3.03.019	PF 4.0, external Ø 5.0 mm, height 12.0 mm	16
3.03.033	Retentive anchor analog, length 13.0 mm	21,49
Implant analog		
3.03.060	PF 3.5, length 22.0 mm	20
3.03.061	PF 4.0, length 22.0 mm	20
3.03.062	PF 5.0, length 22.0 mm	20
3.03.063	PF 6.0, length 22.0 mm	20
3.03.065	PF 4.5, length 22.0 mm	20
Impression coping for open tray technique, single use, retentive, screw-retained, conical		
3.03.071	PF 4.5, external Ø 5.5 mm, height 10.0 mm	17
3.03.072	PF 5.0, external Ø 6.0 mm, height 10.0 mm	17
3.03.073	PF 6.0, external Ø 7.0 mm, height 10.0 mm	17
Impression coping for closed tray technique, single use, repositionable, screw-retained, short		
3.03.074	PF 3.5, external Ø 3.9 mm, height 8.0 mm	16
3.03.075	PF 4.5, external Ø 5.5 mm, height 8.0 mm	16
3.03.076	PF 5.0, external Ø 6.0 mm, height 8.0 mm	16
3.03.077	PF 6.0, external Ø 7.0 mm, height 8.0 mm	16
Impression coping for open tray technique, single use, retentive, screw-retained, conical		
3.03.078	PF 4.0, external Ø 5.0 mm, height 10.0 mm	17
Impression coping for closed tray technique, single use, repositionable, screw-retained, short		
3.03.079	PF 4.0, external Ø 5.0 mm, height 8.0 mm	16
3.03.083	VARIOmulti analog for CAD/CAM, titanium	21,38
3.03.084	Implant-analog for CAD/CAM PF 3.0	12
Implant-analog for CAD/CAM		
3.03.085	PF 3.5, length 11.4 mm	20
3.03.086	PF 4.0, length 11.4 mm	20
3.03.087	PF 4.5, length 11.4 mm	20
3.03.088	PF 5.0, length 11.4 mm	20
3.03.089	PF 6.0, length 11.4 mm	20
Implant analog		
3.03.090	PF 3.5, length 14.0 mm	20
3.03.091	PF 4.5, length 14.0 mm	20
3.03.092	PF 5.0, length 14.0 mm	20
3.03.093	PF 6.0, length 15.0 mm	20

3.03.095	PF 4.0, length 14.0 mm	20
3.03.098	Implant-analog PF 3.0	12
3.03.101	Impression coping for bar, Ø 6.0 mm, height 5.0 mm	19,50
Bar analog		
3.03.105	Ø 4.0 mm, length 21.5 mm	21,50
3.03.140	X-ray reference sphere, Ø 5.0 mm	7
Guiding sleeve for VECTOdrill™ pilot drill (4 pieces)		
3.03.141 Q4	Internal Ø 2.0 mm, length 6.0 mm	7,56
3.03.151	Solder pin for bar, length 13.5 mm	50
3.03.157	Insertion device for VARIOmulti analog for CAD/CAM	21,38,55
Insertion device for implant analog for CAD/CAM		
3.03.158	PF 3.5, length 35.0 mm	12,20,55
3.03.159	PF 4.0-6.0, length 35.0 mm	20,55
3.03.160	MONO torque ratchet, length 110.0 mm	54
MONO insertion device		
3.03.162	short, length 15.4 mm	40,42,55
3.03.163	long, length 25.8 mm	40,42,55
MONO screwdriver (4-lobe)		
3.03.165	extra short, length 14.5 mm, shaft length 5.1 mm	55
3.03.166	short, length 22.2 mm, shaft length 10.3 mm	55
3.03.167	long, length 28.2 mm, shaft length 16.3 mm	55
MONO insertion device for retentive anchor		
3.03.169	length 26.0 mm, Ø 8.5 mm	49
3.03.203	MONO guide key, length 94.7 mm	54
Drill extension		
3.03.230	PF 4.0-6.0, external Ø 5.0 mm, length 26.0 mm	9
3.03.231	PF 3.5-4.0, external Ø 3.7 mm, length 26.0 mm	9
3.03.238	Adapter for hand piece PF 3.0, length 28.0 mm	11
3.03.240	Adapter for hand piece, length 18 mm	54
Adapter for hand piece, one-piece		
3.03.241	PF 4.5-6.0, length 24.0 mm	54,56
3.03.248	PF 3.5, length 24.0 mm	11,54,56
3.03.249	Adapter for hand piece, length 28.0 mm	54
3.03.250	Handle for dental laboratory, length 120.0 mm	20,55
Adapter for hand piece, one-piece		
3.03.251	PF 4.0, length 24.0 mm	54,56
Explantation drill		
long, for ELEMENT and CONTACT PF 3.5, external Ø 4.3 mm, internal Ø 3.8 mm, length 37.0 mm		
3.03.300		58
long, for ELEMENT and CONTACT PF 4.0 and 4.5, external Ø 5.0 mm, internal Ø 4.5 mm, length 37.0 mm		
3.03.301		58
long, for ELEMENT PF 5.0, CONTACT PF 5.0 and 6.0, external Ø 6.3 mm, internal Ø 5.3 mm, length 37.0 mm		
3.03.302		58
short, for ELEMENT and CONTACT PF 3.5, external Ø 4.3 mm, internal Ø 3.8 mm, length 31.0 mm		
3.03.303		58
short, for ELEMENT and CONTACT PF 4.0 and 4.5, external Ø 5.0 mm, internal Ø 4.5 mm, length 31.0 mm		
3.03.304		58
short, for ELEMENT PF 5.0, CONTACT PF 5.0 and 6.0, external Ø 6.3 mm, internal Ø 5.3 mm, length 31.0 mm		
3.03.305		58
short, for ELEMENT PF 6.0		
3.03.306	external Ø 7.3 mm, internal Ø 6.3 mm, length 31.0 mm	58
Guiding cylinder for ELEMENT and CONTACT implants		
3.03.307	PF 4.0, external Ø 4.4 mm, length 3.0 mm	58
3.03.308	PF 3.5, external Ø 3.7 mm, length 3.0 mm	58
3.03.309	PF 4.5, external Ø 4.4 mm, length 3.0 mm	58
ELEMENT PF 5.0, CONTACT PF 5.0 and 6.0, external Ø 5.2 mm, length 3.0 mm		
3.03.310		58
Guiding cylinder for ELEMENT implant		
3.03.313	PF 6.0, external Ø 6.2 mm, length 3.0 mm	58
Mucosa punch, reusable		
3.03.315	PF 3.5, length 27.0 mm	9
3.03.316	PF 4.0, length 27.0 mm	9
3.03.317	PF 5.0, length 27.0 mm	9
3.03.318	PF 6.0, length 27.0 mm	9
3.03.320	PF 4.5, length 27.0 mm	9
VARIO/VARIOmulti reamer for base		
3.03.420	PF 3.5-4.0, length 16.0 mm	40,42
VARIO/VARIOmulti reamer for base		
3.03.421	PF 4.5-6.0, length 16.0 mm	42
VARIO guide pin for VARIO reamer		
3.03.423	PF 4.5-6.0, length 12.5 mm	42
VARIO guide pin for VARIO/VARIOmulti reamer		
3.03.424	PF 3.5, length 15.0 mm	40,42
VARIO guide pin for VARIO reamer		
3.03.425	PF 4.0, length 12.5 mm	42
Gauge for VARIO and VARIOmulti reamers for screw channel, for laboratory use		
3.03.430		40,42
VARIO reamer for screw channel		
3.03.435	PF 3.5, length 44.0 mm	42

3.03.436	PF 4.0–6.0, length 44.0 mm	42
3.03.437	VARIOmulti reamer for screw channel , length 40.0 mm	40
	Screwdriver for hand piece (4-lobe)	
3.03.500	extra short, length 17.0 mm, shaft length 3.5 mm	54
3.03.501	short, length 22.0 mm, shaft length 8.0 mm	54
3.03.502	long, length 28.0 mm, shaft length 14.5 mm	54
3.03.503	extra long, length 38.0 mm, shaft length 24.5 mm	54
	Laboratory screw	
3.03.515	PF 3.5, length 25.0 mm	33
3.03.515 Q5	PF 3.5, length 25.0 mm (5 pieces)	33
3.03.516	PF 4.0–6.0, length 25.0 mm	33
3.03.516 Q5	PF 4.0–6.0, length 25.0 mm (5 pieces)	33
	Positioning handle for angled VARIO and VARIOmulti abutments , length 25.0 mm, Ø 4.0 mm	40,42
3.03.521	Positioning handle , length 17.0 mm, Ø 6.0 mm	16,17
	Screw for impression copings , reusable (4-lobe)	
3.03.572	PF 3.5, extra short, length 12.5 mm	11,16,17,18
3.03.573	PF 3.5, short, length 16.5 mm	16,17
3.03.574	PF 3.5, long, length 21.5 mm	11,17
3.03.575	PF 4.0–6.0, extra short, length 13.2 mm	16,17,18
3.03.576	PF 4.0–6.0, short, length 17.2 mm	16,17
3.03.577	PF 4.0–6.0, long, length 22.2 mm	17
3.03.580	PF 3.5, extra long, length 27.5 mm	11,17
3.03.581	PF 4.0–6.0, extra long, length 28.2 mm	17
	Fabrication screw , for customizable gingiva former and VARIOtemp (4-lobe), for PF 3.5, length 22.5 mm (4 pieces)	15
3.03.590 Q4	Fabrication screw , for customizable gingiva former and VARIOtemp (4-lobe), for PF 4.0–6.0, length 23.4 mm (4 pieces)	15
	Fabrication screw for VARIOmulti temporary cap (4-lobe) length 19.3 mm (4 pieces)	38
	VECTODrill™ twist drill , single use (4 pieces)	
3.03.610 Q4	Pilot drill Ø 2.0 mm, short, length 34.0 mm	8
3.03.611 Q4	Pilot drill Ø 2.0 mm, long, length 40.0 mm	8,10
3.03.612 Q4	Drill Ø 2.8 mm, short, length 34.0 mm	8,10
3.03.613 Q4	Drill Ø 2.8 mm, long, length 40.0 mm	8
3.03.614 Q4	Drill Ø 3.5 mm, short, length 34.0 mm	8
3.03.615 Q4	Drill Ø 3.5 mm, long, length 40.0 mm	8
3.03.616 Q4	Drill Ø 4.3 mm, short, length 34.0 mm	8
3.03.617 Q4	Drill Ø 4.3 mm, long, length 40.0 mm	8
3.03.618 Q4	Drill Ø 5.3 mm, short, length 34.0 mm	8
	Pilot drill Ø 2.0 mm, extra short, length 29.0 mm, for implants of length 6.5–14.0 mm	8
3.03.624 Q4	Drill Ø 2.8 mm, extra short, length 29.0 mm, for implants of length 6.5–14.0 mm	8
3.03.625 Q4	Drill Ø 3.5 mm, extra short, length 29.0 mm, for implants of length 6.5–14.0 mm	8
3.03.626 Q4	Drill Ø 4.3 mm, extra short, length 29.0 mm, for implants of length 6.5–14.0 mm	8
3.03.627 Q4	Drill Ø 5.3 mm, extra short, length 29.0 mm, for implants of length 6.5–14.0 mm	8
3.03.628 Q4	Pilot drill Ø 2.0 mm, extra short, length 29.0 mm, for implants of length 6.5–14.0 mm	8
	VECTODrill™ Depth gauge	
3.03.630	Ø 2.0 mm, length 27.5 mm	8
3.03.632	Ø 2.8 mm, length 27.5 mm	8
3.03.634	Ø 3.5 mm, length 27.5 mm	8
3.03.636	Ø 4.3 mm, length 27.5 mm	8
3.03.638	Ø 5.3 mm, length 27.5 mm	8
	SPI®CONTACT profile drill , single use (4 pieces)	
3.03.640 Q4	2.7/3.5 mm, short, length 34.0 mm	9
3.03.641 Q4	2.7/3.5 mm, extra short, length 29.0 mm	9
3.03.642 Q4	3.5/4.5 mm, short, length 34.0 mm	9
3.03.643 Q4	3.5/4.5 mm, extra short, length 29.0 mm	9
3.03.644 Q4	4.2/5.0 mm, short, length 34.0 mm	9
3.03.645 Q4	4.2/5.0 mm, extra short, length 29.0 mm	9
3.03.646 Q4	5.0/6.0 mm, short, length 34.0 mm	9
3.03.647 Q4	5.0/6.0 mm, extra short, length 29.0 mm	9
3.03.648 Q4	3.5/4.0 mm, short, length 34.0 mm	9
3.03.649 Q4	3.5/4.0 mm, extra short, length 29.0 mm	9
	SPI®ELEMENT profile drill , single use (4 pieces)	
3.03.651 Q4	3.5/3.5 mm, extra short, length 29.0 mm	9
3.03.653 Q4	4.2/4.5 mm, extra short, length 29.0 mm	9
3.03.655 Q4	5.0/5.0 mm, extra short, length 29.0 mm	9
3.03.657 Q4	4.0/4.0 mm, extra short, length 29.0 mm	9
3.03.659 Q4	6.0/6.0 mm, extra short, length 29.0 mm	9
3.03.658	Bone contouring instrument for PF 3.0, reusable	11
	VECTODrill™ ceramic drill , reusable	
	Pilot drill Ø 2.0 mm, extra short, length 29.0 mm, for implants of length 6.5–14.0 mm	8
3.03.660	Pilot drill Ø 2.0 mm, short, length 34.0 mm	8
	Drill Ø 2.8 mm, extra short, length 29.0 mm, for implants of length 6.5–14.0 mm	8

3.03.663	Drill Ø 2.8 mm, short, length 34.0 mm	8
	Drill Ø 3.5 mm, extra short, length 29.0 mm, for implants of length 6.5–14.0 mm	8
3.03.664	Drill Ø 3.5 mm, short, length 34.0 mm	8
3.03.665	Drill Ø 4.3 mm, extra short, length 29.0 mm, for implants of length 6.5–14.0 mm	8
3.03.666	Drill Ø 4.3 mm, short, length 34.0 mm	8
3.03.667	Drill Ø 5.3 mm, extra short, length 29.0 mm, for implants of length 6.5–14.0 mm	8
3.03.668	Drill Ø 5.3 mm, short, length 34.0 mm	8
3.03.669	Bone contouring instrument+ , reusable	9,37
	PF 3.5, length 29.0 mm	
3.03.670	Bone contouring instrument , reusable	9
	PF 3.5, length 29.0 mm	
3.03.671	Bone contouring instrument+ , reusable	9,37
	PF 4.0, length 29.0 mm	
3.03.672	Bone contouring instrument , reusable	9
	PF 4.0, length 29.0 mm	
3.03.673	Bone contouring instrument+ , reusable	9,37
	PF 4.5, length 29.0 mm	
3.03.674	Bone contouring instrument , reusable	9
	PF 4.5, length 29.0 mm	
3.03.675	Bone contouring instrument+ , reusable	9,37
	PF 5.0, length 29.0 mm	
3.03.676	Bone contouring instrument , reusable	9
	PF 5.0, length 29.0 mm	
3.03.677	Thread tap , reusable	9
	endosseous Ø 3.5 mm, length 34.0 mm	
3.03.682	endosseous Ø 4.0 mm, length 34.0 mm	9
3.03.684	endosseous Ø 4.2 mm, length 34.0 mm	9
3.03.686	endosseous Ø 5.0 mm, length 34.0 mm	9
3.03.688	endosseous Ø 6.0 mm, length 34.0 mm	9
	Drill Ø 1.5 mm , single use, short, length 34.0 mm (4 pieces)	8
3.03.690 Q4	Depth gauge Ø 1.5 mm , customizable length, length 30.5 mm	8
	EASY analog	
3.03.700	PF 3.5, cone 4.0 mm, height 14.0 mm	21,44
3.03.701	PF 4.5, cone 4.0 mm, height 14.0 mm	21,44,46
3.03.702	PF 5.0, cone 4.0 mm, height 14.0 mm	21,44,46
3.03.703	PF 6.0, cone 4.0 mm, height 14.0 mm	21,44,46
3.03.704	PF 3.5, cone 6.0 mm, height 16.0 mm	21,44
3.03.705	PF 4.5, cone 6.0 mm, height 16.0 mm	21,44,46,48
3.03.706	PF 5.0, cone 6.0 mm, height 16.0 mm	21,44,46,48
3.03.707	PF 6.0, cone 6.0 mm, height 16.0 mm	21,44,46,48
3.03.708	PF 4.0, cone 4.0 mm, height 14.0 mm	21,44
3.03.709	PF 4.0, cone 6.0 mm, height 16.0 mm	21,44
	VECTODrill™ twist drill , reusable	
	Pilot drill Ø 2.0 mm, extra short, length 29.0 mm, for implants of length 6.5–14.0 mm	8
3.03.710	Drill Ø 2.8 mm, extra short, length 29.0 mm, for implants of length 6.5–14.0 mm	8
3.03.712	Drill Ø 3.5 mm, extra short, length 29.0 mm, for implants of length 6.5–14.0 mm	8
3.03.714	Drill Ø 4.3 mm, extra short, length 29.0 mm, for implants of length 6.5–14.0 mm	8
3.03.716	Drill Ø 5.3 mm, extra short, length 29.0 mm, for implants of length 6.5–14.0 mm	8
3.03.718	Pilot drill Ø 2.0 mm, short, length 34.0 mm	8
3.03.720	Drill Ø 2.8 mm, short, length 34.0 mm	8
3.03.722	Drill Ø 3.5 mm, short, length 34.0 mm	8
3.03.724	Drill Ø 4.3 mm, short, length 34.0 mm	8
3.03.726	Drill Ø 5.3 mm, short, length 34.0 mm	8
3.03.728	Pilot drill Ø 2.0 mm, long, length 40.0 mm	8,10
3.03.730	Drill Ø 2.8 mm, long, length 40.0 mm	8
3.03.732	Drill Ø 3.5 mm, long, length 40.0 mm	8
3.03.734	Drill Ø 4.3 mm, long, length 40.0 mm	8
3.03.736	Drill Ø 5.3 mm, long, length 40.0 mm	8
	SPI®ELEMENT profile drill for PF 3.0, single use	
3.03.740	for implant of length 8.0 mm	10
3.03.741	for implant of length 9.5 mm,	10
3.03.742	for implant of length 11.0 mm	10
3.03.743	for implant of length 12.5 mm	10
3.03.774	Scan abutment PF 3.0	12
	Scan abutment	
3.03.775	PF 3.5	18
3.03.776	PF 4.0	18
3.03.777	PF 4.5	18
3.03.778	PF 5.0	18
3.03.779	PF 6.0	18

3.03.790	Drill Ø 1.5 mm, reusable, short, length 34.0 mm	8
3.03.780	VARIOMulti scan abutment, Ø 4.5 mm, height 8.0 mm	18,39
3.03.781	VARIOMulti scan abutment, Ø 5.0 mm, height 5.0 mm	18,39
3.03.800	VARIOMulti analog, Ø 4.8 mm, height 21.2 mm	21,38
3.03.804	VARIOMulti temporary cap, incl. fabrication screw Ø 5.2 mm, height 15.0 mm	38

3.04	Impression coping for open tray technique, reusable, retentive, screw-retained, cylindrical	
3.04.020	PF 3.5, external Ø 3.8 mm, height 16.0 mm	17
3.04.021	PF 4.0, external Ø 4.3 mm, height 16.0 mm	17
3.04.022	PF 4.5, external Ø 4.8 mm, height 16.0 mm	17
3.04.023	PF 5.0, external Ø 5.3 mm, height 16.0 mm	17
3.04.024	PF 6.0, external Ø 6.3 mm, height 16.0 mm	17
3.04.028	Impression coping PF 3.0, for open tray technique, reusable, retentive, screw-retained, cylindrical	11
	Impression coping for closed tray technique, reusable, repositionable, screw-retained, short	
3.04.030	PF 3.5, external Ø 3.9 mm, height 8.0 mm	16
3.04.031	PF 4.0, external Ø 5.0 mm, height 8.0 mm	16
3.04.032	PF 4.5, external Ø 5.5 mm, height 8.0 mm	16
3.04.033	PF 5.0, external Ø 6.0 mm, height 8.0 mm	16
3.04.034	PF 6.0, external Ø 7.0 mm, height 8.0 mm	16
	Impression coping for open tray technique, reusable, retentive, screw-retained, conical	
3.04.037	PF 4.0, external Ø 5.0 mm, height 16.0 mm	17
3.04.038	PF 4.5, external Ø 5.5 mm, height 16.0 mm	17
3.04.039	PF 5.0, external Ø 6.0 mm, height 16.0 mm	17
3.04.040	PF 6.0, external Ø 7.0 mm, height 16.0 mm	17
	Impression coping for closed tray technique, reusable, repositionable, screw-retained, long	
3.04.046	PF 3.5, external Ø 3.9 mm, height 12.0 mm	16
3.04.047	PF 4.0, external Ø 5.0 mm, height 12.0 mm	16
3.04.048	PF 4.5, external Ø 5.5 mm, height 12.0 mm	16
3.04.049	PF 5.0, external Ø 6.0 mm, height 12.0 mm	16
3.04.050	PF 6.0, external Ø 7.0 mm, height 12.0 mm	16
3.04.080 Q4	Guiding sleeve, length 5.0 mm, Ø 4.8 mm	56
3.04.090	Adapter guided, length 25.5 mm	56
3.04.100	Seating instrument for guiding sleeve Ø 4.8 mm	56
3.04.110	Initial drill, guided, length 28.5 mm	56
	VECTOdrill pilot drill and twist drill, guided	
3.04.111	Pilot drill, Ø 2.0 mm, length 31.5 mm, L 6.5 mm	56
3.04.112	Pilot drill, Ø 2.0 mm, length 33.0 mm, L 8.0 mm	56
3.04.113	Pilot drill, Ø 2.0 mm, length 34.5 mm, L 9.5 mm	56
3.04.114	Pilot drill, Ø 2.0 mm, length 36.0 mm, L 11.0 mm	56
3.04.115	Pilot drill, Ø 2.0 mm, length 37.5 mm, L 12.5 mm	56
3.04.121	Drill, Ø 2.8 mm, length 31.5 mm, L 6.5 mm	56
3.04.122	Drill, Ø 2.8 mm, length 33.0 mm, L 8.0 mm	56
3.04.123	Drill, Ø 2.8 mm, length 34.5 mm, L 9.5 mm	56
3.04.124	Drill, Ø 2.8 mm, length 36.0 mm, L 11.0 mm	56
3.04.125	Drill, Ø 2.8 mm, length 37.5 mm, L 12.5 mm	56
3.04.131	Drill, Ø 3.5 mm, length 31.5 mm, L 6.5 mm	56
3.04.132	Drill, Ø 3.5 mm, length 33.0 mm, L 8.0 mm	56
3.04.133	Drill, Ø 3.5 mm, length 34.5 mm, L 9.5 mm	56
3.04.134	Drill, Ø 3.5 mm, length 36.0 mm, L 11.0 mm	56
3.04.135	Drill, Ø 3.5 mm, length 37.5 mm, L 12.5 mm	56
	Profile drill CONTACT AND ELEMENT, guided	
3.04.171	Profile drill CONTACT MC, Ø 3.5 mm, length 34.0 mm	56
3.04.172	Profile drill CONTACT MC, PF 4.0, length 34.0 mm	56
3.04.173	Profile drill CONTACT MC, PF 4.5, length 34.0 mm	56
3.04.161	Profile drill CONTACT RC, PF 3.5, length 32.5 mm	56
3.04.162	Profile drill CONTACT RC PF 4.0, length 32.5 mm	56
3.04.163	Profile drill CONTACT RC PF 4.5, length 32.5 mm	56
3.04.151	Profile drill ELEMENT MC, PF 3.5, length 30.5 mm	56
3.04.152	Profile drill ELEMENT MC, PF 4.0, length 30.5 mm	56
3.04.153	Profile drill ELEMENT MC, PF 4.5, length 30.5 mm	56
3.04.805	VARIOMulti impression coping, Ø 5.3 mm, height 18.0 mm	19,38

31	Dynamic Titanium Base for crown	
31.311.113.01-2	PF 3.5, height 4.0 mm	34
31.312.114.01-2	PF 4.0, height 4.0 mm	34
31.313.115.01-2	PF 4.5, height 4.0 mm	34
31.314.116.01-2	PF 5.0, height 4.0 mm	34
	Dynamic Titanium Base for crown, customizable length	
31.310.113.21-2	PF 3.5, height 9.0 mm	34
31.312.114.21-2	PF 4.0, height 9.0 mm	34
31.313.115.21-2	PF 4.5, height 9.0 mm	34
31.314.116.21-2	PF 5.0, height 9.0 mm	34

	Dynamic Titanium Base for bridge	
31.321.113.01-2	PF 3.5, height 4.0 mm	34
31.322.114.01-2	PF 4.0, height 4.0 mm	34
31.323.115.01-2	PF 4.5, height 4.0 mm	34
31.324.116.01-2	PF 5.0, height 4.0 mm	34
	Dynamic Titanium Base for bridge, customizable length	
31.320.113.21-2	PF 3.5, height 9.0 mm	34
31.322.114.21-2	PF 4.0, height 9.0 mm	34
31.323.115.21-2	PF 4.5, height 9.0 mm	34
31.324.116.21-2	PF 5.0, height 9.0 mm	34

4.03	EASY abutment, 20°	
4.03.010	PF 3.5, short 0.5 mm, height 6.5 mm	43
4.03.011	PF 4.5, short 0.5 mm, height 6.5 mm	43
4.03.012	PF 5.0, short 0.5 mm, height 6.5 mm	43
4.03.013	PF 6.0, short 0.5 mm, height 6.5 mm	43
4.03.014	PF 3.5, long 3.0 mm, height 8.0 mm	43
4.03.015	PF 4.5, long 3.0 mm, height 9.0 mm	43
4.03.016	PF 5.0, long 3.0 mm, height 9.0 mm	43
4.03.017	PF 6.0, long 3.0 mm, height 9.0 mm	43
4.03.018	PF 4.0, short 0.5 mm, height 6.5 mm	43
4.03.019	PF 4.0, long 3.0 mm, height 9.0 mm	43
	Retentive anchor	
4.03.040	PF 4.5, short, height 1.8 mm	49
4.03.041	PF 4.5, long, height 3.0 mm	49
4.03.042	PF 5.0, short, height 1.8 mm	49
4.03.043	PF 5.0, long, height 3.0 mm	49
4.03.048	PF 4.0, short, height 1.8 mm	49
4.03.049	PF 4.0, long, height 3.0 mm	49
4.03.070	Titanium cap for bar, height 4.7 mm	50
	Bar abutment	
4.03.380	PF 3.5, height 5.5 mm	50
4.03.381	PF 4.5, height 5.5 mm	50
4.03.382	PF 5.0, height 5.5 mm	50
4.03.388	PF 4.0, height 5.5 mm	50
	Milling abutment	
4.03.420	PF 3.5, height 11.0 mm	49
4.03.421	PF 4.5, height 12.0 mm	49
4.03.422	PF 5.0, height 12.0 mm	49
4.03.423	PF 6.0, height 12.0 mm	49
4.03.428	PF 4.0, height 12.0 mm	49
	Abutment screw (4-lobe)	
4.03.515S	PF 3.5, length 5.8 mm	12,15,32,33,35,37,41,43,49
4.03.516S	PF 4.0-6.0, length 7.2 mm	15,32,33,35,37,41,43,46,49
4.03.517S	PF 4.0-6.0, length 10.2 mm	15,32,33,35,37,41,43,46,49
4.03.518S	Occlusal screw for bar (4-lobe), length 4.3 mm	50
4.03.519S	Occlusal screw (4-lobe), length 3.5 mm	37,41
	Healing cap SE (4-lobe)	
4.03.515S	PF 3.5, height 1.0 mm	15
4.03.516S	PF 4.5, height 1.0 mm	15
4.03.517S	PF 5.0, height 1.0 mm	15
4.03.518S	PF 6.0, height 1.0 mm	15
4.03.519S	PF 4.0, height 1.0 mm	15
	Gingiva former for PF 3.0 (4-lobe)	
4.03.538	PF 3.0, height 3.2 mm	10
4.03.548	PF 3.0, height 4.5 mm	10
4.03.558	PF 3.0, height 7.0 mm	10
4.03.525S	Gingiva former+ (4-lobe) PF 3.5, height 2.0 mm	15
	Gingiva former (4-lobe)	
4.03.520S	PF 3.5, height 2.0 mm	15
4.03.521S	PF 4.5, height 2.0 mm	15
4.03.522S	PF 5.0, height 2.0 mm	15
4.03.523S	PF 6.0, height 2.0 mm	15
4.03.524S	PF 4.0, height 2.0 mm	15
	Gingiva former (4-lobe)	
4.03.530S	PF 3.5, height 3.2 mm	15
4.03.531S	PF 4.5, height 3.2 mm	15
4.03.532S	PF 5.0, height 3.2 mm	15
4.03.533S	PF 6.0, height 3.2 mm	15
4.03.534S	PF 4.0, height 3.2 mm	15
4.03.535S	Gingiva former+ (4-lobe) PF 3.5, height 3.2 mm	15
	Gingiva former (4-lobe)	
4.03.540S	PF 3.5, height 4.5 mm	15
4.03.541S	PF 4.5, height 4.5 mm	15
4.03.542S	PF 5.0, height 4.5 mm	15
4.03.543S	PF 6.0, height 4.5 mm	15
4.03.544S	PF 4.0, height 4.5 mm	15
4.03.560S	PF 3.5, height 5.7 mm	15
4.03.564S	PF 4.0, height 5.7 mm	15

4.03.561S	PF 4.5, height 5.7 mm	15
4.03.562S	PF 5.0, height 5.7 mm	15
4.03.563S	PF 6.0, height 5.7 mm	15
4.03.550S	PF 3.5, height 7.0 mm	15
4.03.551S	PF 4.5, height 7.0 mm	15
4.03.552S	PF 5.0, height 7.0 mm	15
4.03.553S	PF 6.0, height 7.0 mm	15
4.03.554S	PF 4.0, height 7.0 mm	15
Gingiva former, customizable		
4.03.570	PF 3.5, height 7.5 mm	15
4.03.571	PF 4.0, height 7.5 mm	15
4.03.572	PF 4.5, height 7.5 mm	15
4.03.573	PF 5.0, height 7.5 mm	15
4.03.574	PF 6.0, height 7.5 mm	15
VARIOmulti abutment, with handle,		
4.03.600	PF 3.5, height 3.0 mm, shoulder height 0.8 mm	37
4.03.601	PF 4.0, height 3.0 mm, shoulder height 0.8 mm	37
4.03.602	PF 4.5, height 3.0 mm, shoulder height 0.8 mm	37
4.03.603	PF 5.0, height 3.0 mm, shoulder height 0.8 mm	37
4.03.604	PF 6.0, height 3.7 mm, shoulder height 1.5 mm	37
4.03.605	PF 3.5, height 4.2 mm, shoulder height 2.0 mm	37
4.03.606	PF 4.0, height 4.2 mm, shoulder height 2.0 mm	37
4.03.607	PF 4.5, height 4.2 mm, shoulder height 2.0 mm	37
4.03.608	PF 5.0, height 4.2 mm, shoulder height 2.0 mm	37
4.03.610	PF 3.5, height 5.2 mm, shoulder height 3.0 mm	37
4.03.611	PF 4.0, height 5.2 mm, shoulder height 3.0 mm	37
4.03.612	PF 4.5, height 5.2 mm, shoulder height 3.0 mm	37
4.03.613	PF 5.0, height 5.2 mm, shoulder height 3.0 mm	37
VARIOmulti abutment angled, 17°		
4.03.680	PF 3.5, height 4.3 mm, shoulder height 2.7 mm	37
4.03.681	PF 4.0, height 4.3 mm, shoulder height 2.7 mm	37
4.03.682	PF 4.5, height 4.3 mm, shoulder height 2.7 mm	37
4.03.683	PF 5.0, height 4.3 mm, shoulder height 2.7 mm	37
4.03.684	PF 6.0, height 4.3 mm, shoulder height 2.7 mm	37
VARIOmulti abutment angled, 30°		
4.03.685	PF 3.5, height 4.4 mm, shoulder height 3.3 mm	37
4.03.686	PF 4.0, height 4.4 mm, shoulder height 3.3 mm	37
4.03.687	PF 4.5, height 4.4 mm, shoulder height 3.3 mm	37
4.03.688	PF 5.0, height 4.4 mm, shoulder height 3.3 mm	37
4.03.689	PF 6.0, height 4.4 mm, shoulder height 3.3 mm	37
EASY abutment		
4.03.700	PF 3.5, short 0.5 mm, cone 4.0 mm, height 4.5 mm	43
4.03.701	PF 4.5, short 0.5 mm, cone 4.0 mm, height 4.5 mm	43
4.03.702	PF 5.0, short 0.5 mm, cone 4.0 mm, height 4.5 mm	43
4.03.703	PF 6.0, short 0.5 mm, cone 4.0 mm, height 4.5 mm	43
4.03.704	PF 3.5, short 0.5 mm, cone 6.0 mm, height 6.5 mm	43
4.03.705	PF 4.5, short 0.5 mm, cone 6.0 mm, height 6.5 mm	43
4.03.706	PF 5.0, short 0.5 mm, cone 6.0 mm, height 6.5 mm	43
4.03.707	PF 6.0, short 0.5 mm, cone 6.0 mm, height 6.5 mm	43
4.03.708	PF 4.0, short 0.5 mm, cone 4.0 mm, height 4.5 mm	43
4.03.709	PF 4.0, short 0.5 mm, cone 6.0 mm, height 6.5 mm	43
4.03.710	PF 3.5, long 2.0 mm, cone 4.0 mm, height 6.0 mm	43
4.03.711	PF 4.5, long 2.0 mm, cone 4.0 mm, height 6.0 mm	43
4.03.712	PF 5.0, long 2.0 mm, cone 4.0 mm, height 6.0 mm	43
4.03.713	PF 6.0, long 2.0 mm, cone 4.0 mm, height 6.0 mm	43
4.03.714	PF 3.5, long 2.0 mm, cone 6.0 mm, height 8.0 mm	43
4.03.715	PF 4.5, long 2.0 mm, cone 6.0 mm, height 8.0 mm	43
4.03.716	PF 5.0, long 2.0 mm, cone 6.0 mm, height 8.0 mm	43
4.03.717	PF 6.0, long 2.0 mm, cone 6.0 mm, height 8.0 mm	43
4.03.718	PF 4.0, long 2.0 mm, cone 4.0 mm, height 6.0 mm	43
4.03.719	PF 4.0, long 2.0 mm, cone 6.0 mm, height 8.0 mm	43
EASY abutment e.p.		
4.03.721	PF 4.5/5.0, cone 4.0 mm, height 7.0 mm	45
4.03.722	PF 5.0/6.0, cone 4.0 mm, height 7.0 mm	45
4.03.725	PF 4.5/5.0, cone 6.0 mm, height 9.0 mm	45
4.03.726	PF 5.0/6.0, cone 6.0 mm, height 9.0 mm	45
4.03.728	PF 4.0/4.5, cone 4.0 mm, height 7.0 mm	45
4.03.729	PF 4.0/4.5, cone 6.0 mm, height 9.0 mm	45
EASY abutment		
4.03.734	PF 3.5, extra long 4.0 mm, cone 6.0 mm, height 10.0 mm	43
4.03.735	PF 4.5, extra long 4.0 mm, cone 6.0 mm, height 10.0 mm	43
4.03.736	PF 5.0, extra long 4.0 mm, cone 6.0 mm, height 10.0 mm	43
4.03.739	PF 4.0, extra long 4.0 mm, cone 6.0 mm, height 10.0 mm	43
4.03.801	VARIOmulti protective cap Ø 5.3 mm, height 4.5 mm	38
Gingiva former narrow (4-lobe)		
4.04.310S	PF 3.5, height 2.0 mm	15
4.04.311S	PF 4.0, height 2.0 mm	15
4.04.312S	PF 4.5, height 2.0 mm	15
4.04.313S	PF 5.0, height 2.0 mm	15

4.04.314S	PF 6.0, height 2.0 mm	15
4.04.320S	PF 3.5, height 3.2 mm	15
4.04.321S	PF 4.0, height 3.2 mm	15
4.04.322S	PF 4.5, height 3.2 mm	15
4.04.323S	PF 5.0, height 3.2 mm	15
4.04.324S	PF 6.0, height 3.2 mm	15
4.04.330S	PF 3.5, height 4.5 mm	15
4.04.331S	PF 4.0, height 4.5 mm	15
4.04.332S	PF 4.5, height 4.5 mm	15
4.04.333S	PF 5.0, height 4.5 mm	15
4.04.334S	PF 6.0, height 4.5 mm	15
4.04.340S	PF 3.5, height 5.7 mm	15
4.04.341S	PF 4.0, height 5.7 mm	15
4.04.342S	PF 4.5, height 5.7 mm	15
4.04.343S	PF 5.0, height 5.7 mm	15
4.04.344S	PF 6.0, height 5.7 mm	15
4.04.350S	PF 3.5, height 7.0 mm	15
4.04.351S	PF 4.0, height 7.0 mm	15
4.04.352S	PF 4.5, height 7.0 mm	15
4.04.353S	PF 5.0, height 7.0 mm	15
4.04.354S	PF 6.0, height 7.0 mm	15

4.13

CONTACT implant, incl. healing cap		
4.13.211	PF 4.5, endosseous Ø 3.5 mm, length 9.5 mm	6
4.13.212	PF 5.0, endosseous Ø 4.2 mm, length 9.5 mm	6
4.13.213	PF 6.0, endosseous Ø 5.0 mm, length 9.5 mm	6
4.13.214	PF 4.0, endosseous Ø 3.5 mm, length 9.5 mm	6
4.13.220	PF 3.5, endosseous Ø 2.7 mm, length 11.0 mm	6
4.13.221	PF 4.5, endosseous Ø 3.5 mm, length 11.0 mm	6
4.13.222	PF 5.0, endosseous Ø 4.2 mm, length 11.0 mm	6
4.13.223	PF 6.0, endosseous Ø 5.0 mm, length 11.0 mm	6
4.13.224	PF 4.0, endosseous Ø 3.5 mm, length 11.0 mm	6
4.13.230	PF 3.5, endosseous Ø 2.7 mm, length 12.5 mm	6
4.13.231	PF 4.5, endosseous Ø 3.5 mm, length 12.5 mm	6
4.13.232	PF 5.0, endosseous Ø 4.2 mm, length 12.5 mm	6
4.13.233	PF 6.0, endosseous Ø 5.0 mm, length 12.5 mm	6
4.13.234	PF 4.0, endosseous Ø 3.5 mm, length 12.5 mm	6
4.13.240	PF 3.5, endosseous Ø 2.7 mm, length 14.0 mm	6
4.13.241	PF 4.5, endosseous Ø 3.5 mm, length 14.0 mm	6
4.13.242	PF 5.0, endosseous Ø 4.2 mm, length 14.0 mm	6
4.13.243	PF 6.0, endosseous Ø 5.0 mm, length 14.0 mm	6
4.13.244	PF 4.0, endosseous Ø 3.5 mm, length 14.0 mm	6
4.13.261	PF 4.5, endosseous Ø 3.5 mm, length 17.0 mm	6
4.13.262	PF 5.0, endosseous Ø 4.2 mm, length 17.0 mm	6
ELEMENT implant, incl. healing cap		
4.13.900	PF 3.5, endosseous Ø 3.5 mm, length 8.0 mm	6
4.13.901	PF 4.5, endosseous Ø 4.2 mm, length 8.0 mm	6
4.13.902	PF 5.0, endosseous Ø 5.0 mm, length 8.0 mm	6
4.13.903	PF 6.0, endosseous Ø 6.0 mm, length 8.0 mm	6
4.13.904	PF 4.0, endosseous Ø 4.0 mm, length 8.0 mm	6
4.13.905	PF 4.0, endosseous Ø 4.0 mm, length 6.5 mm	6
4.13.906	PF 4.5, endosseous Ø 4.2 mm, length 6.5 mm	6
4.13.907	PF 5.0, endosseous Ø 5.0 mm, length 6.5 mm	6
4.13.908	PF 6.0, endosseous Ø 6.0 mm, length 6.5 mm	6
4.13.910	PF 3.5, endosseous Ø 3.5 mm, length 11.0 mm	6
4.13.911	PF 4.5, endosseous Ø 4.2 mm, length 11.0 mm	6
4.13.912	PF 5.0, endosseous Ø 5.0 mm, length 11.0 mm	6
4.13.913	PF 6.0, endosseous Ø 6.0 mm, length 11.0 mm	6
4.13.914	PF 4.0, endosseous Ø 4.0 mm, length 9.5 mm	6
4.13.920	PF 3.5, endosseous Ø 3.5 mm, length 14.0 mm	6
4.13.921	PF 4.5, endosseous Ø 4.2 mm, length 14.0 mm	6
4.13.922	PF 5.0, endosseous Ø 5.0 mm, length 14.0 mm	6
4.13.924	PF 4.0, endosseous Ø 4.0 mm, length 11.0 mm	6
4.13.930	PF 3.5, endosseous Ø 3.5 mm, length 17.0 mm	6
4.13.931	PF 4.5, endosseous Ø 4.2 mm, length 17.0 mm	6
4.13.934	PF 4.0, endosseous Ø 4.0 mm, length 12.5 mm	6
4.13.940	PF 3.5, endosseous Ø 3.5 mm, length 9.5 mm	6
4.13.941	PF 4.5, endosseous Ø 4.2 mm, length 9.5 mm	6
4.13.942	PF 5.0, endosseous Ø 5.0 mm, length 9.5 mm	6
4.13.943	PF 6.0, endosseous Ø 6.0 mm, length 9.5 mm	6
4.13.944	PF 4.0, endosseous Ø 4.0 mm, length 14.0 mm	6
4.13.950	PF 3.5, endosseous Ø 3.5 mm, length 12.5 mm	6
4.13.951	PF 4.5, endosseous Ø 4.2 mm, length 12.5 mm	6
4.13.952	PF 5.0, endosseous Ø 5.0 mm, length 12.5 mm	6
4.13.953	PF 6.0, endosseous Ø 6.0 mm, length 12.5 mm	6

4.23

ELEMENT implant RC INICELL® PF 3.0, incl. healing cap		
4.23.102	PF 3.0, length 8.0 mm	10
4.23.103	PF 3.0, length 9.5 mm	10

4.23.104	PF 3.0, length 11.5 mm	10
4.23.105	PF 3.0, length 12.5 mm	10
ELEMENT implant RC INICELL®, incl. healing cap		
4.23.112	PF 3.5, endosseous Ø 3.5 mm, length 8.0 mm	4
4.23.113	PF 3.5, endosseous Ø 3.5 mm, length 9.5 mm	4
4.23.114	PF 3.5, endosseous Ø 3.5 mm, length 11.0 mm	4
4.23.115	PF 3.5, endosseous Ø 3.5 mm, length 12.5 mm	4
4.23.116	PF 3.5, endosseous Ø 3.5 mm, length 14.0 mm	4
4.23.117	PF 3.5, endosseous Ø 3.5 mm, length 17.0 mm	4
4.23.121	PF 4.0, endosseous Ø 4.0 mm, length 6.5 mm	4
4.23.122	PF 4.0, endosseous Ø 4.0 mm, length 8.0 mm	4
4.23.123	PF 4.0, endosseous Ø 4.0 mm, length 9.5 mm	4
4.23.124	PF 4.0, endosseous Ø 4.0 mm, length 11.0 mm	4
4.23.125	PF 4.0, endosseous Ø 4.0 mm, length 12.5 mm	4
4.23.126	PF 4.0, endosseous Ø 4.0 mm, length 14.0 mm	4
4.23.131	PF 4.5, endosseous Ø 4.2 mm, length 6.5 mm	4
4.23.132	PF 4.5, endosseous Ø 4.2 mm, length 8.0 mm	4
4.23.133	PF 4.5, endosseous Ø 4.2 mm, length 9.5 mm	4
4.23.134	PF 4.5, endosseous Ø 4.2 mm, length 11.0 mm	4
4.23.135	PF 4.5, endosseous Ø 4.2 mm, length 12.5 mm	4
4.23.136	PF 4.5, endosseous Ø 4.2 mm, length 14.0 mm	4
4.23.137	PF 4.5, endosseous Ø 4.2 mm, length 17.0 mm	4
4.23.141	PF 5.0, endosseous Ø 5.0 mm, length 6.5 mm	4
4.23.142	PF 5.0, endosseous Ø 5.0 mm, length 8.0 mm	4
4.23.143	PF 5.0, endosseous Ø 5.0 mm, length 9.5 mm	4
4.23.144	PF 5.0, endosseous Ø 5.0 mm, length 11.0 mm	4
4.23.145	PF 5.0, endosseous Ø 5.0 mm, length 12.5 mm	4
4.23.146	PF 5.0, endosseous Ø 5.0 mm, length 14.0 mm	4
4.23.151	PF 6.0, endosseous Ø 6.0 mm, length 6.5 mm	4
4.23.152	PF 6.0, endosseous Ø 6.0 mm, length 8.0 mm	4
4.23.153	PF 6.0, endosseous Ø 6.0 mm, length 9.5 mm	4
4.23.154	PF 6.0, endosseous Ø 6.0 mm, length 11.0 mm	4
4.23.155	PF 6.0, endosseous Ø 6.0 mm, length 12.5 mm	4
CONTACT implant RC INICELL®, incl. healing cap		
4.23.214	PF 3.5, endosseous Ø 2.7 mm, length 11.0 mm	5
4.23.215	PF 3.5, endosseous Ø 2.7 mm, length 12.5 mm	5
4.23.216	PF 3.5, endosseous Ø 2.7 mm, length 14.0 mm	5
4.23.223	PF 4.0, endosseous Ø 3.5 mm, length 9.5 mm	5
4.23.224	PF 4.0, endosseous Ø 3.5 mm, length 11.0 mm	5
4.23.225	PF 4.0, endosseous Ø 3.5 mm, length 12.5 mm	5
4.23.226	PF 4.0, endosseous Ø 3.5 mm, length 14.0 mm	5
4.23.233	PF 4.5, endosseous Ø 3.5 mm, length 9.5 mm	5
4.23.234	PF 4.5, endosseous Ø 3.5 mm, length 11.0 mm	5
4.23.235	PF 4.5, endosseous Ø 3.5 mm, length 12.5 mm	5
4.23.236	PF 4.5, endosseous Ø 3.5 mm, length 14.0 mm	5
4.23.237	PF 4.5, endosseous Ø 3.5 mm, length 17.0 mm	5
4.23.243	PF 5.0, endosseous Ø 4.2 mm, length 9.5 mm	5
4.23.244	PF 5.0, endosseous Ø 4.2 mm, length 11.0 mm	5
4.23.245	PF 5.0, endosseous Ø 4.2 mm, length 12.5 mm	5
4.23.246	PF 5.0, endosseous Ø 4.2 mm, length 14.0 mm	5
4.23.247	PF 5.0, endosseous Ø 4.2 mm, length 17.0 mm	5
4.23.253	PF 6.0, endosseous Ø 5.0 mm, length 9.5 mm	5
4.23.254	PF 6.0, endosseous Ø 5.0 mm, length 11.0 mm	5
4.23.255	PF 6.0, endosseous Ø 5.0 mm, length 12.5 mm	5
4.23.256	PF 6.0, endosseous Ø 5.0 mm, length 14.0 mm	5
ELEMENT implant MC INICELL®, incl. healing cap		
4.23.512	PF 3.5, endosseous Ø 3.5 mm, length 8.0 mm	4
4.23.513	PF 3.5, endosseous Ø 3.5 mm, length 9.5 mm	4
4.23.514	PF 3.5, endosseous Ø 3.5 mm, length 11.0 mm	4
4.23.515	PF 3.5, endosseous Ø 3.5 mm, length 12.5 mm	4
4.23.516	PF 3.5, endosseous Ø 3.5 mm, length 14.0 mm	4
4.23.522	PF 4.0, endosseous Ø 4.0 mm, length 8.0 mm	4
4.23.523	PF 4.0, endosseous Ø 4.0 mm, length 9.5 mm	4
4.23.524	PF 4.0, endosseous Ø 4.0 mm, length 11.0 mm	4
4.23.525	PF 4.0, endosseous Ø 4.0 mm, length 12.5 mm	4
4.23.526	PF 4.0, endosseous Ø 4.0 mm, length 14.0 mm	4
4.23.532	PF 4.5, endosseous Ø 4.2 mm, length 8.0 mm	4
4.23.533	PF 4.5, endosseous Ø 4.2 mm, length 9.5 mm	4
4.23.534	PF 4.5, endosseous Ø 4.2 mm, length 11.0 mm	4
4.23.535	PF 4.5, endosseous Ø 4.2 mm, length 12.5 mm	4
4.23.536	PF 4.5, endosseous Ø 4.2 mm, length 14.0 mm	4
4.23.542	PF 5.0, endosseous Ø 5.0 mm, length 8.0 mm	4
4.23.543	PF 5.0, endosseous Ø 5.0 mm, length 9.5 mm	4
4.23.544	PF 5.0, endosseous Ø 5.0 mm, length 11.0 mm	4
4.23.545	PF 5.0, endosseous Ø 5.0 mm, length 12.5 mm	4
4.23.546	PF 5.0, endosseous Ø 5.0 mm, length 14.0 mm	4
4.23.552	PF 6.0, endosseous Ø 6.0 mm, length 8.0 mm	4
4.23.553	PF 6.0, endosseous Ø 6.0 mm, length 9.5 mm	4
4.23.554	PF 6.0, endosseous Ø 6.0 mm, length 11.0 mm	4
4.23.555	PF 6.0, endosseous Ø 6.0 mm, length 12.5 mm	4
CONTACT implant MC INICELL®, incl. healing cap		
4.23.615	PF 3.5, endosseous Ø 2.7 mm, length 12.5 mm	5
4.23.616	PF 3.5, endosseous Ø 2.7 mm, length 14.0 mm	5
4.23.617	PF 3.5, endosseous Ø 2.7 mm, length 15.5 mm	5
4.23.624	PF 4.0, endosseous Ø 3.5 mm, length 11.0 mm	5
4.23.625	PF 4.0, endosseous Ø 3.5 mm, length 12.5 mm	5
4.23.626	PF 4.0, endosseous Ø 3.5 mm, length 14.0 mm	5
4.23.627	PF 4.0, endosseous Ø 3.5 mm, length 15.5 mm	5
4.23.634	PF 4.5, endosseous Ø 3.5 mm, length 11.0 mm	5
4.23.635	PF 4.5, endosseous Ø 3.5 mm, length 12.5 mm	5
4.23.636	PF 4.5, endosseous Ø 3.5 mm, length 14.0 mm	5
4.23.637	PF 4.5, endosseous Ø 3.5 mm, length 15.5 mm	5
4.23.644	PF 5.0, endosseous Ø 4.2 mm, length 11.0 mm	5
4.23.645	PF 5.0, endosseous Ø 4.2 mm, length 12.5 mm	5
4.23.646	PF 5.0, endosseous Ø 4.2 mm, length 14.0 mm	5
4.23.647	PF 5.0, endosseous Ø 4.2 mm, length 15.5 mm	5
4.23.654	PF 6.0, endosseous Ø 5.0 mm, length 11.0 mm	5
4.23.655	PF 6.0, endosseous Ø 5.0 mm, length 12.5 mm	5
4.23.656	PF 6.0, endosseous Ø 5.0 mm, length 14.0 mm	5
4.23.657	PF 6.0, endosseous Ø 5.0 mm, length 15.5 mm	5
ELEMENT implant LC INICELL®, incl. healing cap		
4.23.712	PF 3.5, endosseous Ø 3.5 mm, length 8.0 mm	4
4.23.713	PF 3.5, endosseous Ø 3.5 mm, length 9.5 mm	4
4.23.714	PF 3.5, endosseous Ø 3.5 mm, length 11.0 mm	4
4.23.715	PF 3.5, endosseous Ø 3.5 mm, length 12.5 mm	4
4.23.716	PF 3.5, endosseous Ø 3.5 mm, length 14.0 mm	4
4.23.721	PF 4.0, endosseous Ø 4.0 mm, length 6.5 mm	4
4.23.722	PF 4.0, endosseous Ø 4.0 mm, length 8.0 mm	4
4.23.723	PF 4.0, endosseous Ø 4.0 mm, length 9.5 mm	4
4.23.724	PF 4.0, endosseous Ø 4.0 mm, length 11.0 mm	4
4.23.725	PF 4.0, endosseous Ø 4.0 mm, length 12.5 mm	4
4.23.726	PF 4.0, endosseous Ø 4.0 mm, length 14.0 mm	4
41	Dynamic abutment screw (6-lobe)	
41.314.069.01-2	PF 3.5, length 6.6 mm	34
41.316.076.02-2	PF 4.0-5.0, length 7.2 mm	34
43	Dynamic screwdriver (6-lobe)	
43.618.201.01-2	length 18.0 mm	34
43.624.201.01-2	length 24.0 mm	34
43.632.201.01-2	length 32.0 mm	34
8.03	Screw organizer for prosthetic cassette	
8.03.019	length 56.0 mm, width 47.0 mm, height 28.0 mm	57
Ultrasonic cleaning-cassette		
8.03.059	length 160.0 mm, width 72.0 mm, height 28.0 mm	57
Instrument holder set, for surgical cassette		
8.03.090 Q2	consisting of 2 holders, size S	57
8.03.091	consisting of 1 holder, size M	57
83	8393 LOCATOR® core tool	52
84	LOCATOR® abutment	
8461	PF 4.0, collar height 1.0 mm	51
8462	PF 4.0, collar height 2.0 mm	51
8463	PF 4.0, collar height 3.0 mm	51
8464	PF 4.0, collar height 4.0 mm	51
8465	PF 4.0, collar height 5.0 mm	51
8466	PF 4.0, collar height 6.0 mm	51
85	LOCATOR® impression coping (4 pieces)	19,52
8514	LOCATOR® block-out spacer (20 pieces)	52
8515-20	LOCATOR® male processing, black (20 pieces)	52
LOCATOR® analog, Ø 5.0 mm		
8516	(preferably used with PF 5.0 and 6.0) (4 pieces)	21,52
8517	LOCATOR® parallel posts (4 pieces)	52
8519-2	LOCATOR® laboratory set (pack contains 2 sets)	51
LOCATOR® male replacement (4 pieces)		
8524	clear	51
8527	pink, «light retention»	51
8529	blue, «extra-light retention»	51
LOCATOR® analog, Ø 4.0 mm (preferably used with PF 3.5, 4.0 and 4.5) (4 pieces)		
8530		21,52
LOCATOR® laboratory set, for extended range (pack contains 2 sets)		
8540-2		51
LOCATOR® male replacement, for extended range (4 pieces)		

	8547	green	51
	8548	red «extra-light retention»	51
87/88		LOCATOR® abutment	
	8786	PF 4.5, collar height 1.0 mm	51
	8787	PF 4.5, collar height 2.0 mm	51
	8788	PF 4.5, collar height 3.0 mm	51
	8789	PF 4.5, collar height 4.0 mm	51
	8790	PF 4.5, collar height 5.0 mm	51
	8791	PF 4.5, collar height 6.0 mm	51
	8792	PF 5.0, collar height 1.0 mm	51
	8793	PF 5.0, collar height 2.0 mm	51
	8794	PF 5.0, collar height 3.0 mm	51
	8795	PF 5.0, collar height 4.0 mm	51
	8796	PF 5.0, collar height 5.0 mm	51
	8797	PF 5.0, collar height 6.0 mm	51
	8875	PF 3.5, collar height 0.73 mm	51
	8876	PF 3.5, collar height 2.0 mm	51
	8877	PF 3.5, collar height 3.0 mm	51
	8878	PF 3.5, collar height 4.0 mm	51
	8879	PF 3.5, collar height 5.0 mm, only available in the US	51
	8880	PF 3.5, collar height 6.0 mm, only available in the US	51
	8881	PF 6.0, collar height 1.0 mm	51
	8882	PF 6.0, collar height 2.0 mm	51
	8883	PF 6.0, collar height 3.0 mm	51
	8884	PF 6.0, collar height 4.0 mm	51
89		LOCATOR® abutment and collar for VARIOmulti	
	8909-2	{2 pieces} collar height 3.0 mm	51
		LOCATOR® insert for hand piece and for short MONO insert device	
	8913	length 23.0 mm	52
	8914	length 29.0 mm	52
		LOCATOR® male replacement for extended range orange, «light retention» {4 pieces}	
	8915		51
95	9530	LOCATOR® angle measurement guide, height 15.0 mm, width 50.0 mm	52
ER		Container for surgical cassette, incl. identification plate Thommen Medical	
	ER510.080E	length 312.0 mm, width 189.0 mm, height 83.0 mm	57
		Single-use-paper-filter {100 per pack} length 118.0 mm, width 235.0 mm	57
	ER802.000N		57
		Permanent filter, 1200 sterilization cycles length 95.0 mm, width 215.0 mm	57
	ER802.020		57
Fo		X-ray template, for planning with two-dimensional x-ray devices	
	Fo_20d184	for the ELEMENT implant line	7,10
	Fo_20d185	for the CONTACT implant line	7

Alphabetical index

A Abutment screw (4-lobe)

PF 3.5, length 5.8 mm	4.03.500	12,15,32,33,35, 37,41,43,49
PF 4.0-6.0, length 7.2 mm	4.03.501	15,32,33,35,37 41,43,46,49
PF 4.0-6.0, length 10.2 mm	4.03.502	15,32,33,35,37 41,43,46,49
Adapter, guided, length 25.5 mm	3.04.090	56
Adapter for hand piece PF 3.0, length 28.0 mm	3.03.238	11
Adapter for hand piece, one-piece		
PF 3.5, length 24.0 mm	3.03.248	11,54,56
PF 4.0, length 24.0 mm	3.03.251	54,56
PF 4.5-6.0, length 24.0 mm	3.03.241	54,56
Adapter for hand piece		
length 18.0 mm	3.03.240	54
length 28.0 mm	3.03.249	54
ART abutment, incl. abutment screw		
PF 3.5/4.5, cone 6.0 mm, height 9.0 mm	1.03.623	47
PF 4.0/4.5, cone 6.0 mm, height 9.0 mm	1.03.624	47
PF 4.5/5.0, cone 6.0 mm, height 9.0 mm	1.03.625	47
PF 5.0/6.0, cone 6.0 mm, height 9.0 mm	1.03.626	47
ART grinding cylinder-abutment, incl. abutment screw		
PF 3.5, height 12.0 mm	1.03.649	47
PF 4.0, height 12.0 mm	1.03.650	47
PF 4.5, height 12.0 mm	1.03.651	47
PF 5.0, height 12.0 mm	1.03.652	47

B Bar abutment

PF 3.5, height 5.5 mm	4.03.380	50
PF 4.0, height 5.5 mm	4.03.388	50
PF 4.5, height 5.5 mm	4.03.381	50
PF 5.0, height 5.5 mm	4.03.382	50
Bar analog Ø 4.0 mm, length 21.5 mm	3.03.105	21,50
Bone contouring instrument for PF 3.0, reusable	3.03.658	11
Bone contouring instrument, reusable		
PF 3.5, length 29.0 mm	3.03.671	9
PF 4.0, length 29.0 mm	3.03.673	9
PF 4.5, length 29.0 mm	3.03.675	9
PF 5.0, length 29.0 mm	3.03.677	9
PF 6.0, length 29.0 mm	3.03.679	9
Bone contouring instrument+, reusable		
PF 3.5, length 29.0 mm	3.03.670	9,37
PF 4.0, length 29.0 mm	3.03.672	9,37
PF 4.5, length 29.0 mm	3.03.674	9,37
PF 5.0, length 29.0 mm	3.03.676	9,37

C CONTACT implant, incl. healing cap

PF 3.5, endosseous Ø 2.7 mm, length 11.0 mm	4.13.220	6
PF 3.5, endosseous Ø 2.7 mm, length 12.5 mm	4.13.230	6
PF 3.5, endosseous Ø 2.7 mm, length 14.0 mm	4.13.240	6
PF 4.0, endosseous Ø 3.5 mm, length 9.5 mm	4.13.214	6
PF 4.0, endosseous Ø 3.5 mm, length 11.0 mm	4.13.224	6
PF 4.0, endosseous Ø 3.5 mm, length 12.5 mm	4.13.234	6
PF 4.0, endosseous Ø 3.5 mm, length 14.0 mm	4.13.244	6
PF 4.5, endosseous Ø 3.5 mm, length 9.5 mm	4.13.211	6
PF 4.5, endosseous Ø 3.5 mm, length 11.0 mm	4.13.221	6
PF 4.5, endosseous Ø 3.5 mm, length 12.5 mm	4.13.231	6
PF 4.5, endosseous Ø 3.5 mm, length 14.0 mm	4.13.241	6
PF 4.5, endosseous Ø 3.5 mm, length 17.0 mm	4.13.261	6
PF 5.0, endosseous Ø 4.2 mm, length 9.5 mm	4.13.212	6
PF 5.0, endosseous Ø 4.2 mm, length 11.0 mm	4.13.222	6
PF 5.0, endosseous Ø 4.2 mm, length 12.5 mm	4.13.232	6
PF 5.0, endosseous Ø 4.2 mm, length 14.0 mm	4.13.242	6
PF 5.0, endosseous Ø 4.2 mm, length 17.0 mm	4.13.262	6
PF 6.0, endosseous Ø 5.0 mm, length 9.5 mm	4.13.213	6
PF 6.0, endosseous Ø 5.0 mm, length 11.0 mm	4.13.223	6
PF 6.0, endosseous Ø 5.0 mm, length 12.5 mm	4.13.233	6
PF 6.0, endosseous Ø 5.0 mm, length 14.0 mm	4.13.243	6
CONTACT implant MC INICELL®, incl. healing cap		
PF 3.5, endosseous Ø 2.7 mm, length 12.5 mm	4.23.615	5
PF 3.5, endosseous Ø 2.7 mm, length 14.0 mm	4.23.616	5
PF 3.5, endosseous Ø 2.7 mm, length 15.5 mm	4.23.617	5
PF 4.0, endosseous Ø 3.5 mm, length 11.0 mm	4.23.624	5
PF 4.0, endosseous Ø 3.5 mm, length 12.5 mm	4.23.625	5
PF 4.0, endosseous Ø 3.5 mm, length 14.0 mm	4.23.626	5
PF 4.0, endosseous Ø 3.5 mm, length 15.5 mm	4.23.627	5
PF 4.5, endosseous Ø 3.5 mm, length 11.0 mm	4.23.634	5
PF 4.5, endosseous Ø 3.5 mm, length 12.5 mm	4.23.635	5

PF 4.5, endosseous Ø 3.5 mm, length 14.0 mm	4.23.636	5
PF 4.5, endosseous Ø 3.5 mm, length 15.5 mm	4.23.637	5
PF 5.0, endosseous Ø 4.2 mm, length 11.0 mm	4.23.644	5
PF 5.0, endosseous Ø 4.2 mm, length 12.5 mm	4.23.645	5
PF 5.0, endosseous Ø 4.2 mm, length 14.0 mm	4.23.646	5
PF 5.0, endosseous Ø 4.2 mm, length 15.5 mm	4.23.647	5
PF 6.0, endosseous Ø 5.0 mm, length 11.0 mm	4.23.654	5
PF 6.0, endosseous Ø 5.0 mm, length 12.5 mm	4.23.655	5
PF 6.0, endosseous Ø 5.0 mm, length 14.0 mm	4.23.656	5
PF 6.0, endosseous Ø 5.0 mm, length 15.5 mm	4.23.657	5
CONTACT implant RC INICELL®, incl. healing cap		
PF 3.5, endosseous Ø 2.7 mm, length 11.0 mm	4.23.214	5
PF 3.5, endosseous Ø 2.7 mm, length 12.5 mm	4.23.215	5
PF 3.5, endosseous Ø 2.7 mm, length 14.0 mm	4.23.216	5
PF 4.0, endosseous Ø 3.5 mm, length 9.5 mm	4.23.223	5
PF 4.0, endosseous Ø 3.5 mm, length 11.0 mm	4.23.224	5
PF 4.0, endosseous Ø 3.5 mm, length 12.5 mm	4.23.225	5
PF 4.0, endosseous Ø 3.5 mm, length 14.0 mm	4.23.226	5
PF 4.5, endosseous Ø 3.5 mm, length 9.5 mm	4.23.233	5
PF 4.5, endosseous Ø 3.5 mm, length 11.0 mm	4.23.234	5
PF 4.5, endosseous Ø 3.5 mm, length 12.5 mm	4.23.235	5
PF 4.5, endosseous Ø 3.5 mm, length 14.0 mm	4.23.236	5
PF 4.5, endosseous Ø 3.5 mm, length 17.0 mm	4.23.237	5
PF 5.0, endosseous Ø 4.2 mm, length 9.5 mm	4.23.243	5
PF 5.0, endosseous Ø 4.2 mm, length 11.0 mm	4.23.244	5
PF 5.0, endosseous Ø 4.2 mm, length 12.5 mm	4.23.245	5
PF 5.0, endosseous Ø 4.2 mm, length 14.0 mm	4.23.246	5
PF 5.0, endosseous Ø 4.2 mm, length 17.0 mm	4.23.247	5
PF 6.0, endosseous Ø 5.0 mm, length 9.5 mm	4.23.253	5
PF 6.0, endosseous Ø 5.0 mm, length 11.0 mm	4.23.254	5
PF 6.0, endosseous Ø 5.0 mm, length 12.5 mm	4.23.255	5
PF 6.0, endosseous Ø 5.0 mm, length 14.0 mm	4.23.256	5

SPI®CONTACT profile drill, single use (4 pieces)

2.7/3.5 mm, extra short, length 29.0 mm	3.03.641 Q4	9
2.7/3.5 mm, short, length 34.0 mm	3.03.640 Q4	9
3.5/4.0 mm, extra short, length 29.0 mm	3.03.649 Q4	9
3.5/4.0 mm, short, length 34.0 mm	3.03.648 Q4	9
3.5/4.5 mm, extra short, length 29.0 mm	3.03.643 Q4	9
3.5/4.5 mm, short, length 34.0 mm	3.03.642 Q4	9
4.2/5.0 mm, extra short, length 29.0 mm	3.03.645 Q4	9
4.2/5.0 mm, short, length 34.0 mm	3.03.644 Q4	9
5.0/6.0 mm, extra short, length 29.0 mm	3.03.647 Q4	9
5.0/6.0 mm, short, length 34.0 mm	3.03.646 Q4	9

Container for surgical cassette, incl. identification plate Thommen Medical length 312.0 mm, width 189.0 mm, height 83.0 mm

ER510.080E 57

D Depth gauge Ø 1.5 mm, customizable length, length 30.5 mm

3.03.692 8

Drill Ø 1.5 mm, single use, short, length 34.0 mm (4 pieces)

3.03.690 Q4 8

Drill Ø 1.5 mm, reusable, short, length 34.0 mm

3.03.790 8

Drill extension

PF 3.5-4.0, external Ø 3.7 mm, length 26.0 mm 3.03.231 9

PF 4.0-6.0, external Ø 5.0 mm, length 26.0 mm 3.03.230 9

Dynamic Titanium Base for crown

PF 3.5, height 4.0 mm 31.311.113.01-2 34

PF 4.0, height 4.0 mm 31.312.114.01-2 34

PF 4.5, height 4.0 mm 31.313.115.01-2 34

PF 5.0, height 4.0 mm 31.314.116.01-2 34

Dynamic Titanium Base for crown, customizable length

PF 3.5, height 9.0 mm 31.310.113.21-2 34

PF 4.0, height 9.0 mm 31.312.114.21-2 34

PF 4.5, height 9.0 mm 31.313.115.21-2 34

PF 5.0, height 9.0 mm 31.314.116.21-2 34

Dynamic Titanium Base for bridge

PF 3.5, height 4.0 mm 31.321.113.01-2 34

PF 4.0, height 4.0 mm 31.322.114.01-2 34

PF 4.5, height 4.0 mm 31.323.115.01-2 34

PF 5.0, height 4.0 mm 31.324.116.01-2 34

Dynamic Titanium Base for bridge, customizable length

PF 3.5, height 9.0 mm 31.320.113.21-2 34

PF 4.0, height 9.0 mm 31.322.114.21-2 34

PF 4.5, height 9.0 mm 31.323.115.21-2 34

PF 5.0, height 9.0 mm 31.324.116.21-2 34

Dynamic abutment screw (6-lobe)

PF 3.5, length 6.6 mm 41.314.069.01-2 34

PF 4.0-5.0, length 7.2 mm 41.316.076.02-2 34

Dynamic screwdriver (6-lobe)

length 18.0 mm 43.618.201.01-2 34

length 24.0 mm 43.624.201.01-2 34

length 32.0 mm	43.632.201.01-2	34
E EASY impression coping		
PF 3.5, cone 4.0 mm, height 9.5 mm	2.03.700	19,44
PF 3.5, cone 6.0 mm, height 11.5 mm	2.03.704	19,44
PF 4.0, cone 4.0 mm, height 9.5 mm	2.03.708	19,44
PF 4.0, cone 6.0 mm, height 11.5 mm	2.03.709	19,44
PF 4.5, cone 4.0 mm, height 9.5 mm	2.03.701	19,44,46
PF 4.5, cone 6.0 mm, height 11.5 mm	2.03.705	19,44,46,48
PF 5.0, cone 4.0 mm, height 9.5 mm	2.03.702	19,44,46
PF 5.0, cone 6.0 mm, height 11.5 mm	2.03.706	19,44,46,48
PF 6.0, cone 4.0 mm, height 9.5 mm	2.03.703	19,44,46
PF 6.0, cone 6.0 mm, height 11.5 mm	2.03.707	19,44,46,48
EASY abutment, 20°		
PF 3.5, short 0.5 mm, height 6.5 mm	4.03.010	43
PF 3.5, long 3.0 mm, height 8.0 mm	4.03.014	43
PF 4.0, short 0.5 mm, height 6.5 mm	4.03.018	43
PF 4.0, long 3.0 mm, height 9.0 mm	4.03.019	43
PF 4.5, short 0.5 mm, height 6.5 mm	4.03.011	43
PF 4.5, long 3.0 mm, height 9.0 mm	4.03.015	43
PF 5.0, short 0.5 mm, height 6.5 mm	4.03.012	43
PF 5.0, long 3.0 mm, height 9.0 mm	4.03.016	43
PF 6.0, short 0.5 mm, height 6.5 mm	4.03.013	43
PF 6.0, long 3.0 mm, height 9.0 mm	4.03.017	43
EASY abutment set, extra long		
PF 3.5, collar 4.0 mm, cone 6.0 mm, height 10.0 mm	1.04.734	43
PF 4.0, collar 4.0 mm, cone 6.0 mm, height 10.0 mm	1.04.739	43
PF 4.5, collar 4.0 mm, cone 6.0 mm, height 10.0 mm	1.04.735	43
PF 5.0, collar 4.0 mm, cone 6.0 mm, height 10.0 mm	1.04.736	43
EASY abutment set, short		
PF 3.5, collar 0.5 mm, cone 4.0 mm, height 4.5 mm	1.04.700	43
PF 3.5, collar 0.5 mm, cone 6.0 mm, height 6.5 mm	1.04.704	43
PF 4.0, collar 0.5 mm, cone 4.0 mm, height 4.5 mm	1.04.708	43
PF 4.0, collar 0.5 mm, cone 6.0 mm, height 6.5 mm	1.04.709	43
PF 4.5, collar 0.5 mm, cone 4.0 mm, height 4.5 mm	1.04.701	43
PF 4.5, collar 0.5 mm, cone 6.0 mm, height 6.5 mm	1.04.705	43
PF 5.0, collar 0.5 mm, cone 4.0 mm, height 4.5 mm	1.04.702	43
PF 5.0, collar 0.5 mm, cone 6.0 mm, height 6.5 mm	1.04.706	43
PF 6.0, collar 0.5 mm, cone 4.0 mm, height 4.5 mm	1.04.703	43
PF 6.0, collar 0.5 mm, cone 6.0 mm, height 6.5 mm	1.04.707	43
EASY abutment set, long		
PF 3.5, collar 2.0 mm, cone 4.0 mm, height 6.0 mm	1.04.710	43
PF 3.5, collar 2.0 mm, cone 6.0 mm, height 8.0 mm	1.04.714	43
PF 4.0, collar 2.0 mm, cone 4.0 mm, height 6.0 mm	1.04.718	43
PF 4.0, collar 2.0 mm, cone 6.0 mm, height 8.0 mm	1.04.719	43
PF 4.5, collar 2.0 mm, cone 4.0 mm, height 6.0 mm	1.04.711	43
PF 4.5, collar 2.0 mm, cone 6.0 mm, height 8.0 mm	1.04.715	43
PF 5.0, collar 2.0 mm, cone 4.0 mm, height 6.0 mm	1.04.712	43
PF 5.0, collar 2.0 mm, cone 6.0 mm, height 8.0 mm	1.04.716	43
PF 6.0, collar 2.0 mm, cone 4.0 mm, height 6.0 mm	1.04.713	43
PF 6.0, collar 2.0 mm, cone 6.0 mm, height 8.0 mm	1.04.717	43
EASY abutment e.p.		
PF 4.0/4.5, cone 4.0 mm, height 7.0 mm	4.03.728	45
PF 4.0/4.5, cone 6.0 mm, height 9.0 mm	4.03.729	45
PF 4.5/5.0, cone 4.0 mm, height 7.0 mm	4.03.721	45
PF 4.5/5.0, cone 6.0 mm, height 9.0 mm	4.03.725	45
PF 5.0/6.0, cone 4.0 mm, height 7.0 mm	4.03.722	45
PF 5.0/6.0, cone 6.0 mm, height 9.0 mm	4.03.726	45
EASY abutment		
PF 3.5, short 0.5 mm, cone 4.0 mm, height 4.5 mm	4.03.700	43
PF 3.5, short 0.5 mm, cone 6.0 mm, height 6.5 mm	4.03.704	43
PF 3.5, long 2.0 mm, cone 4.0 mm, height 6.0 mm	4.03.710	43
PF 3.5, long 2.0 mm, cone 6.0 mm, height 8.0 mm	4.03.714	43
PF 3.5, extra long 4.0 mm, cone 6.0 mm, height 10.0 mm	4.03.734	43
PF 4.0, short 0.5 mm, cone 4.0 mm, height 4.5 mm	4.03.708	43
PF 4.0, short 0.5 mm, cone 6.0 mm, height 6.5 mm	4.03.709	43
PF 4.0, long 2.0 mm, cone 4.0 mm, height 6.0 mm	4.03.718	43
PF 4.0, long 2.0 mm, cone 6.0 mm, height 8.0 mm	4.03.719	43
PF 4.0, extra long 4.0 mm, cone 6.0 mm, height 10.0 mm	4.03.739	43
PF 4.5, short 0.5 mm, cone 4.0 mm, height 4.5 mm	4.03.701	43
PF 4.5, short 0.5 mm, cone 6.0 mm, height 6.5 mm	4.03.705	43
PF 4.5, long 2.0 mm, cone 4.0 mm, height 6.0 mm	4.03.711	43
PF 4.5, long 2.0 mm, cone 6.0 mm, height 8.0 mm	4.03.715	43
PF 4.5, extra long 4.0 mm, cone 6.0 mm, height 10.0 mm	4.03.735	43
PF 5.0, short 0.5 mm, cone 4.0 mm, height 4.5 mm	4.03.702	43
PF 5.0, short 0.5 mm, cone 6.0 mm, height 6.5 mm	4.03.706	43
PF 5.0, long 2.0 mm, cone 4.0 mm, height 6.0 mm	4.03.712	43
PF 5.0, long 2.0 mm, cone 6.0 mm, height 8.0 mm	4.03.716	43

PF 5.0, extra long 4.0 mm, cone 6.0 mm, height 10.0 mm	4.03.736	43
PF 6.0, short 0.5 mm, cone 4.0 mm, height 4.5 mm	4.03.703	43
PF 6.0, short 0.5 mm, cone 6.0 mm, height 6.5 mm	4.03.707	43
PF 6.0, long 2.0 mm, cone 4.0 mm, height 6.0 mm	4.03.713	43
PF 6.0, long 2.0 mm, cone 6.0 mm, height 8.0 mm	4.03.717	43
EASY analog		
PF 3.5, cone 4.0 mm, height 14.0 mm	3.03.700	21,44
PF 3.5, cone 6.0 mm, height 16.0 mm	3.03.704	21,44
PF 4.0, cone 4.0 mm, height 14.0 mm	3.03.708	21,44
PF 4.0, cone 6.0 mm, height 16.0 mm	3.03.709	21,44
PF 4.5, cone 4.0 mm, height 14.0 mm	3.03.701	21,44,46
PF 4.5, cone 6.0 mm, height 16.0 mm	3.03.705	21,44,46,48
PF 5.0, cone 4.0 mm, height 14.0 mm	3.03.702	21,44,46
PF 5.0, cone 6.0 mm, height 16.0 mm	3.03.706	21,44,46,48
PF 6.0, cone 4.0 mm, height 14.0 mm	3.03.703	21,44,46
PF 6.0, cone 6.0 mm, height 16.0 mm	3.03.707	21,44,46,48
EASY burn-out cap for bridge		
PF 3.5, cone 4.0 mm, height 4.7 mm	2.03.730	44
PF 3.5, cone 6.0 mm, height 6.7 mm	2.03.734	44
PF 4.0, cone 4.0 mm, height 4.7 mm	2.03.738	44
PF 4.0, cone 6.0 mm, height 6.7 mm	2.03.739	44
PF 4.5, cone 4.0 mm, height 4.7 mm	2.03.731	44,46
PF 4.5, cone 6.0 mm, height 6.7 mm	2.03.735	44,46
PF 5.0, cone 4.0 mm, height 4.7 mm	2.03.732	44,46
PF 5.0, cone 6.0 mm, height 6.7 mm	2.03.736	44,46
PF 6.0, cone 4.0 mm, height 4.7 mm	2.03.733	44,46
PF 6.0, cone 6.0 mm, height 6.7 mm	2.03.737	44,46
EASY burn-out cap, for crown, burn-out plastic		
PF 3.5, cone 4.0 mm, height 4.7 mm	2.03.720	44
PF 3.5, cone 6.0 mm, height 6.7 mm	2.03.724	44
PF 4.0, cone 4.0 mm, height 4.7 mm	2.03.728	44
PF 4.0, cone 6.0 mm, height 6.7 mm	2.03.729	44
PF 4.5, cone 4.0 mm, height 4.7 mm	2.03.721	44,46
PF 4.5, cone 6.0 mm, height 6.7 mm	2.03.725	44,46
PF 5.0, cone 4.0 mm, height 4.7 mm	2.03.722	44,46
PF 5.0, cone 6.0 mm, height 6.7 mm	2.03.726	44,46
PF 6.0, cone 4.0 mm, height 4.7 mm	2.03.723	44,46
PF 6.0, cone 6.0 mm, height 6.7 mm	2.03.727	44,46
EASY temporary cap		
PF 3.5, cone 4.0 mm, height 5.0 mm	2.03.740	44
PF 3.5, cone 6.0 mm, height 7.0 mm	2.03.744	44
PF 4.0, cone 4.0 mm, height 5.0 mm	2.03.748	44
PF 4.0, cone 6.0 mm, height 7.0 mm	2.03.749	44
PF 4.5, cone 4.0 mm, height 5.0 mm	2.03.741	44,46
PF 4.5, cone 6.0 mm, height 7.0 mm	2.03.745	44,46,48
PF 5.0, cone 4.0 mm, height 5.0 mm	2.03.742	44,46
PF 5.0, cone 6.0 mm, height 7.0 mm	2.03.746	44,46,48
PF 6.0, cone 4.0 mm, height 5.0 mm	2.03.743	44,46
PF 6.0, cone 6.0 mm, height 7.0 mm	2.03.747	44,46,48
ELEMENT implant, incl. healing cap		
PF 3.5, endosseous Ø 3.5 mm, length 8.0 mm	4.13.900	6
PF 3.5, endosseous Ø 3.5 mm, length 9.5 mm	4.13.940	6
PF 3.5, endosseous Ø 3.5 mm, length 11.0 mm	4.13.910	6
PF 3.5, endosseous Ø 3.5 mm, length 12.5 mm	4.13.950	6
PF 3.5, endosseous Ø 3.5 mm, length 14.0 mm	4.13.920	6
PF 3.5, endosseous Ø 3.5 mm, length 17.0 mm	4.13.930	6
PF 4.0, endosseous Ø 4.0 mm, length 6.5 mm	4.13.905	6
PF 4.0, endosseous Ø 4.0 mm, length 8.0 mm	4.13.904	6
PF 4.0, endosseous Ø 4.0 mm, length 9.5 mm	4.13.914	6
PF 4.0, endosseous Ø 4.0 mm, length 11.0 mm	4.13.924	6
PF 4.0, endosseous Ø 4.0 mm, length 12.5 mm	4.13.934	6
PF 4.0, endosseous Ø 4.0 mm, length 14.0 mm	4.13.944	6
PF 4.5, endosseous Ø 4.2 mm, length 6.5 mm	4.13.906	6
PF 4.5, endosseous Ø 4.2 mm, length 8.0 mm	4.13.901	6
PF 4.5, endosseous Ø 4.2 mm, length 9.5 mm	4.13.941	6
PF 4.5, endosseous Ø 4.2 mm, length 11.0 mm	4.13.911	6
PF 4.5, endosseous Ø 4.2 mm, length 12.5 mm	4.13.951	6
PF 4.5, endosseous Ø 4.2 mm, length 14.0 mm	4.13.921	6
PF 4.5, endosseous Ø 4.2 mm, length 17.0 mm	4.13.931	6
PF 5.0, endosseous Ø 5.0 mm, length 6.5 mm	4.13.907	6
PF 5.0, endosseous Ø 5.0 mm, length 8.0 mm	4.13.902	6
PF 5.0, endosseous Ø 5.0 mm, length 9.5 mm	4.13.942	6
PF 5.0, endosseous Ø 5.0 mm, length 11.0 mm	4.13.912	6
PF 5.0, endosseous Ø 5.0 mm, length 12.5 mm	4.13.952	6
PF 5.0, endosseous Ø 5.0 mm, length 14.0 mm	4.13.922	6
PF 6.0, endosseous Ø 6.0 mm, length 6.5 mm	4.13.908	6
PF 6.0, endosseous Ø 6.0 mm, length 8.0 mm	4.13.903	6
PF 6.0, endosseous Ø 6.0 mm, length 9.5 mm	4.13.943	6

PF 6.0, endosseous Ø 6.0 mm, length 11.0 mm	4.13.913	6
PF 6.0, endosseous Ø 6.0 mm, length 12.5 mm	4.13.953	6
ELEMENT implant LC INICELL® , incl. healing cap		
PF 3.5, endosseous Ø 3.5 mm, length 8.0 mm	4.23.712	4
PF 3.5, endosseous Ø 3.5 mm, length 9.5 mm	4.23.713	4
PF 3.5, endosseous Ø 3.5 mm, length 11.0 mm	4.23.714	4
PF 3.5, endosseous Ø 3.5 mm, length 12.5 mm	4.23.715	4
PF 3.5, endosseous Ø 3.5 mm, length 14.0 mm	4.23.716	4
PF 4.0, endosseous Ø 4.0 mm, length 6.5 mm	4.23.721	4
PF 4.0, endosseous Ø 4.0 mm, length 8.0 mm	4.23.722	4
PF 4.0, endosseous Ø 4.0 mm, length 9.5 mm	4.23.723	4
PF 4.0, endosseous Ø 4.0 mm, length 11.0 mm	4.23.724	4
PF 4.0, endosseous Ø 4.0 mm, length 12.5 mm	4.23.725	4
PF 4.0, endosseous Ø 4.0 mm, length 14.0 mm	4.23.726	4
ELEMENT implant MC INICELL® , incl. healing cap		
PF 3.5, endosseous Ø 3.5 mm, length 8.0 mm	4.23.512	4
PF 3.5, endosseous Ø 3.5 mm, length 9.5 mm	4.23.513	4
PF 3.5, endosseous Ø 3.5 mm, length 11.0 mm	4.23.514	4
PF 3.5, endosseous Ø 3.5 mm, length 12.5 mm	4.23.515	4
PF 3.5, endosseous Ø 3.5 mm, length 14.0 mm	4.23.516	4
PF 4.0, endosseous Ø 4.0 mm, length 8.0 mm	4.23.522	4
PF 4.0, endosseous Ø 4.0 mm, length 9.5 mm	4.23.523	4
PF 4.0, endosseous Ø 4.0 mm, length 11.0 mm	4.23.524	4
PF 4.0, endosseous Ø 4.0 mm, length 12.5 mm	4.23.525	4
PF 4.0, endosseous Ø 4.0 mm, length 14.0 mm	4.23.526	4
PF 4.5, endosseous Ø 4.2 mm, length 8.0 mm	4.23.532	4
PF 4.5, endosseous Ø 4.2 mm, length 9.5 mm	4.23.533	4
PF 4.5, endosseous Ø 4.2 mm, length 11.0 mm	4.23.534	4
PF 4.5, endosseous Ø 4.2 mm, length 12.5 mm	4.23.535	4
PF 4.5, endosseous Ø 4.2 mm, length 14.0 mm	4.23.536	4
PF 5.0, endosseous Ø 5.0 mm, length 8.0 mm	4.23.542	4
PF 5.0, endosseous Ø 5.0 mm, length 9.5 mm	4.23.543	4
PF 5.0, endosseous Ø 5.0 mm, length 11.0 mm	4.23.544	4
PF 5.0, endosseous Ø 5.0 mm, length 12.5 mm	4.23.545	4
PF 5.0, endosseous Ø 5.0 mm, length 14.0 mm	4.23.546	4
PF 6.0, endosseous Ø 6.0 mm, length 8.0 mm	4.23.552	4
PF 6.0, endosseous Ø 6.0 mm, length 9.5 mm	4.23.553	4
PF 6.0, endosseous Ø 6.0 mm, length 11.0 mm	4.23.554	4
PF 6.0, endosseous Ø 6.0 mm, length 12.5 mm	4.23.555	4
ELEMENT implant RC INICELL® , incl. healing cap		
PF 3.5, endosseous Ø 3.5 mm, length 8.0 mm	4.23.112	4
PF 3.5, endosseous Ø 3.5 mm, length 9.5 mm	4.23.113	4
PF 3.5, endosseous Ø 3.5 mm, length 11.0 mm	4.23.114	4
PF 3.5, endosseous Ø 3.5 mm, length 12.5 mm	4.23.115	4
PF 3.5, endosseous Ø 3.5 mm, length 14.0 mm	4.23.116	4
PF 3.5, endosseous Ø 3.5 mm, length 17.0 mm	4.23.117	4
PF 4.0, endosseous Ø 4.0 mm, length 6.5 mm	4.23.121	4
PF 4.0, endosseous Ø 4.0 mm, length 8.0 mm	4.23.122	4
PF 4.0, endosseous Ø 4.0 mm, length 9.5 mm	4.23.123	4
PF 4.0, endosseous Ø 4.0 mm, length 11.0 mm	4.23.124	4
PF 4.0, endosseous Ø 4.0 mm, length 12.5 mm	4.23.125	4
PF 4.0, endosseous Ø 4.0 mm, length 14.0 mm	4.23.126	4
PF 4.5, endosseous Ø 4.2 mm, length 6.5 mm	4.23.131	4
PF 4.5, endosseous Ø 4.2 mm, length 8.0 mm	4.23.132	4
PF 4.5, endosseous Ø 4.2 mm, length 9.5 mm	4.23.133	4
PF 4.5, endosseous Ø 4.2 mm, length 11.0 mm	4.23.134	4
PF 4.5, endosseous Ø 4.2 mm, length 12.5 mm	4.23.135	4
PF 4.5, endosseous Ø 4.2 mm, length 14.0 mm	4.23.136	4
PF 4.5, endosseous Ø 4.2 mm, length 17.0 mm	4.23.137	4
PF 5.0, endosseous Ø 5.0 mm, length 6.5 mm	4.23.141	4
PF 5.0, endosseous Ø 5.0 mm, length 8.0 mm	4.23.142	4
PF 5.0, endosseous Ø 5.0 mm, length 9.5 mm	4.23.143	4
PF 5.0, endosseous Ø 5.0 mm, length 11.0 mm	4.23.144	4
PF 5.0, endosseous Ø 5.0 mm, length 12.5 mm	4.23.145	4
PF 5.0, endosseous Ø 5.0 mm, length 14.0 mm	4.23.146	4
PF 6.0, endosseous Ø 6.0 mm, length 8.5 mm	4.23.151	4
PF 6.0, endosseous Ø 6.0 mm, length 8.5 mm	4.23.152	4
PF 6.0, endosseous Ø 6.0 mm, length 9.5 mm	4.23.153	4
PF 6.0, endosseous Ø 6.0 mm, length 11.0 mm	4.23.154	4
PF 6.0, endosseous Ø 6.0 mm, length 12.5 mm	4.23.155	4
SPI®ELEMENT profile drill for PF 3.0 , single use		
PF 3.0, for length 8.0 mm	3.03.740	10
PF 3.0, for length 9.5 mm	3.03.741	10
PF 3.0, for length 11.0 mm	3.03.742	10
PF 3.0, for length 12.5 mm	3.03.743	10
ELEMENT implants RC INICELL PF 3.0 , incl. healing cap		
PF 3.0, for length 8.0 mm	4.23.102	10
PF 3.0, for length 9.5 mm	4.23.103	10

PF 3.0, for length 11.0 mm	4.23.104	10
PF 3.0, for length 12.5 mm	4.23.105	10
SPI®ELEMENT profile drill , single use (4 pieces)		
3.5/3.5 mm, extra short, length 29.0 mm	3.03.651 Q4	9
4.0/4.0 mm, extra short, length 29.0 mm	3.03.657 Q4	9
4.2/4.5 mm, extra short, length 29.0 mm	3.03.653 Q4	9
5.0/5.0 mm, extra short, length 29.0 mm	3.03.655 Q4	9
6.0/6.0 mm, extra short, length 29.0 mm	3.03.659 Q4	9
Explantation drill		
short, for ELEMENT and CONTACT PF 3.5, external Ø 4.3 mm, internal Ø 3.8 mm, length 31.0 mm	3.03.303	58
short, for ELEMENT and CONTACT PF 4.0 and 4.5, external Ø 5.0 mm, internal Ø 4.5 mm, length 31.0 mm	3.03.304	58
short, for ELEMENT PF 5.0, CONTACT PF 5.0 and 6.0, external Ø 6.3 mm, internal Ø 5.3 mm, length 31.0 mm	3.03.305	58
short, for ELEMENT PF 6.0		
external Ø 7.3 mm, internal Ø 6.3 mm, length 31.0 mm	3.03.306	58
long, for ELEMENT and CONTACT PF 3.5,		
External Ø 4.3 mm, internal Ø 3.8 mm, length 37.0 mm	3.03.300	58
long, for ELEMENT and CONTACT PF 4.0 and 4.5,		
external Ø 5.0 mm, internal Ø 4.5 mm, length 37.0 mm	3.03.301	58
long, for ELEMENT PF 5.0, CONTACT PF 5.0 and 6.0,		
external Ø 6.3 mm, internal Ø 5.3 mm, length 37.0 mm	3.03.302	58

F Fabrication screw , for customizable gingiva former and VARIOtemp (4-lobe)		
PF 3.5, length 22.5 mm (4 pieces)	3.03.590 Q4	15
PF 4.0-6.0, length 23.4 mm (4 pieces)	3.03.591 Q4	15
Fabrication screw for VARIOmulti temporary cap (4-lobe), length 19.3 mm (4 pieces)	3.03.598 Q4	38

G Gauge for VARIO and VARIOmulti reamers for screw channel , for laboratory use	3.03.430	40,42
Gingiva former (4-lobe)		
PF 3.5, height 2.0 mm	4.03.520S	15
PF 3.5, height 3.2 mm	4.03.530S	15
PF 3.5, height 4.5 mm	4.03.540S	15
PF 3.5, height 5.7 mm	4.03.560S	15
PF 3.5, height 7.0 mm	4.03.550S	15
PF 4.0, height 2.0 mm	4.03.524S	15
PF 4.0, height 3.2 mm	4.03.534S	15
PF 4.0, height 4.5 mm	4.03.544S	15
PF 4.0, height 5.7 mm	4.03.564S	15
PF 4.0, height 7.0 mm	4.03.554S	15
PF 4.5, height 2.0 mm	4.03.521S	15
PF 4.5, height 3.2 mm	4.03.531S	15
PF 4.5, height 4.5 mm	4.03.541S	15
PF 4.5, height 5.7 mm	4.03.561S	15
PF 4.5, height 7.0 mm	4.03.551S	15
PF 5.0, height 2.0 mm	4.03.522S	15
PF 5.0, height 3.2 mm	4.03.532S	15
PF 5.0, height 4.5 mm	4.03.542S	15
PF 5.0, height 5.7 mm	4.03.562S	15
PF 5.0, height 7.0 mm	4.03.552S	15
PF 6.0, height 2.0 mm	4.03.523S	15
PF 6.0, height 3.2 mm	4.03.533S	15
PF 6.0, height 4.5 mm	4.03.543S	15
PF 6.0, height 5.7 mm	4.03.563S	15
PF 6.0, height 7.0 mm	4.03.553S	15
Gingiva former narrow (4-lobe)		
PF 3.5, height 2.0 mm	4.04.310S	15
PF 4.0, height 2.0 mm	4.04.311S	15
PF 4.5, height 2.0 mm	4.04.312S	15
PF 5.0, height 2.0 mm	4.04.313S	15
PF 6.0, height 2.0 mm	4.04.314S	15
PF 3.5, height 3.2 mm	4.04.320S	15
PF 4.0, height 3.2 mm	4.04.321S	15
PF 4.5, height 3.2 mm	4.04.322S	15
PF 5.0, height 3.2 mm	4.04.323S	15
PF 6.0, height 3.2 mm	4.04.324S	15
PF 3.5, height 4.5 mm	4.04.330S	15
PF 4.0, height 4.5 mm	4.04.331S	15
PF 4.5, height 4.5 mm	4.04.332S	15
PF 5.0, height 4.5 mm	4.04.333S	15
PF 6.0, height 4.5 mm	4.04.334S	15
PF 3.5, height 5.7 mm	4.04.340S	15
PF 4.0, height 5.7 mm	4.04.341S	15
PF 4.5, height 5.7 mm	4.04.342S	15

PF 5.0, height 5.7 mm	4.04.343S	15		
PF 6.0, height 5.7 mm	4.04.344S	15		
PF 3.5, height 7.0 mm	4.04.350S	15		
PF 4.0, height 7.0 mm	4.04.351S	15		
PF 4.5, height 7.0 mm	4.04.352S	15		
PF 5.0, height 7.0 mm	4.04.353S	15		
PF 6.0, height 7.0 mm	4.04.354S	15		
Gingiva former for PF 3.0, (4-lobe)				
PF 3.0, height 3.2 mm	4.03.538	10		
PF 3.0, height 4.5 mm	4.03.548	10		
PF 3.0, height 7.0 mm	4.03.558	10		
Gingiva former, customizable				
PF 3.5, height 7.5 mm	4.03.570	15		
PF 4.0, height 7.5 mm	4.03.571	15		
PF 4.5, height 7.5 mm	4.03.572	15		
PF 5.0, height 7.5 mm	4.03.573	15		
PF 6.0, height 7.5 mm	4.03.574	15		
Gingiva former+ (4-lobe)				
PF 3.5, height 2.0 mm	4.03.525S	15		
PF 3.5, height 3.2 mm	4.03.535S	15		
Gold cap for bar, height 4.7 mm	2.03.335	50		
Guiding sleeve for VECTODRILL™ pilot drill (4 pieces)				
Internal Ø 2.0 mm, length 6.0 mm	3.03.141 Q4	7,56		
Guiding sleeve, length 5.0 mm, Ø 4.8 mm	3.04.080 Q4	56		
Guiding cylinder for ELEMENT and CONTACT implants				
PF 3.5, external Ø 3.7 mm, length 3.0 mm	3.03.308	58		
PF 4.0, external Ø 4.4 mm, length 3.0 mm	3.03.307	58		
PF 6.0, external Ø 6.2 mm, length 3.0 mm	3.03.313	58		
PF 4.5, external Ø 4.4 mm, length 3.0 mm	3.03.309	58		
ELEMENT PF 5.0, 5.0 and 6.0, external Ø 5.2 mm, length 3.0 mm	3.03.310	58		
H Handle for dental laboratory, length 120.0 mm			3.03.250	20,55
Healing cap SE (4-lobe)				
PF 3.5, height 1.0 mm	4.03.515S	15		
PF 4.0, height 1.0 mm	4.03.519S	15		
PF 4.5, height 1.0 mm	4.03.516S	15		
PF 5.0, height 1.0 mm	4.03.517S	15		
PF 6.0, height 1.0 mm	4.03.518S	15		
I Implant analog PF 3.0, length 14.0 mm			3.03.098	12
Implant analogs for CAD/CAM PF 3.0, length 11.0 mm			3.03.084	12
Implant analog				
PF 3.5, length 14.0 mm	3.03.090	20		
PF 3.5, length 22.0 mm	3.03.060	20		
PF 4.0, length 14.0 mm	3.03.095	20		
PF 4.0, length 22.0 mm	3.03.061	20		
PF 4.5, length 14.0 mm	3.03.091	20		
PF 4.5, length 22.0 mm	3.03.065	20		
PF 5.0, length 14.0 mm	3.03.092	20		
PF 5.0, length 22.0 mm	3.03.062	20		
PF 6.0, length 15.0 mm	3.03.093	20		
PF 6.0, length 22.0 mm	3.03.063	20		
Implant-analog for CAD/CAM				
PF 3.5, length 11.4 mm	3.03.085	20		
PF 4.0, length 11.4 mm	3.03.086	20		
PF 4.5, length 11.4 mm	3.03.087	20		
PF 5.0, length 11.4 mm	3.03.088	20		
PF 6.0, length 11.4 mm	3.03.089	20		
Impression coping for closed tray technique, single use, repositionable, screw-retained, short				
PF 3.5, external Ø 3.9 mm, height 8.0 mm	3.03.074	16		
PF 4.0, external Ø 5.0 mm, height 8.0 mm	3.03.079	16		
PF 4.5, external Ø 5.5 mm, height 8.0 mm	3.03.075	16		
PF 5.0, external Ø 6.0 mm, height 8.0 mm	3.03.076	16		
PF 6.0, external Ø 7.0 mm, height 8.0 mm	3.03.077	16		
Impression coping for closed tray technique, single use, repositionable, screw-retained, long				
PF 3.5, external Ø 3.9 mm, height 12.0 mm	3.03.014	16		
PF 4.0, external Ø 5.0 mm, height 12.0 mm	3.03.019	16		
PF 4.5, external Ø 5.5 mm, height 12.0 mm	3.03.015	16		
PF 5.0, external Ø 6.0 mm, height 12.0 mm	3.03.016	16		
PF 6.0, external Ø 7.0 mm, height 12.0 mm	3.03.017	16		
Impression coping for closed tray technique, reusable, repositionable, screw-retained, short				
PF 3.5, external Ø 3.9 mm, height 8.0 mm	3.04.030	16		
PF 4.0, external Ø 5.0 mm, height 8.0 mm	3.04.031	16		
PF 4.5, external Ø 5.5 mm, height 8.0 mm	3.04.032	16		
PF 5.0, external Ø 6.0 mm, height 8.0 mm	3.04.033	16		
PF 6.0, external Ø 7.0 mm, height 8.0 mm	3.04.034	16		
Impression coping for closed tray technique, reusable, repositionable, screw-retained, long				
PF 3.5, external Ø 3.9 mm, height 12.0 mm	3.04.046	16		
PF 4.0, external Ø 5.0 mm, height 12.0 mm	3.04.047	16		
PF 4.5, external Ø 5.5 mm, height 12.0 mm	3.04.048	16		
PF 5.0, external Ø 6.0 mm, height 12.0 mm	3.04.049	16		
PF 6.0, external Ø 7.0 mm, height 12.0 mm	3.04.050	16		
Impression coping for open tray technique, single use, retentive, screw-retained, conical				
PF 4.0, external Ø 5.0 mm, height 10.0 mm	3.03.078	17		
PF 4.5, external Ø 5.5 mm, height 10.0 mm	3.03.071	17		
PF 5.0, external Ø 6.0 mm, height 10.0 mm	3.03.072	17		
PF 6.0, external Ø 7.0 mm, height 10.0 mm	3.03.073	17		
Impression coping for open tray technique, single use, retentive, screw-retained, cylindrical				
PF 3.5, external Ø 3.8 mm, height 10.0 mm	3.03.010	17		
PF 4.0, external Ø 4.3 mm, height 10.0 mm	3.03.018	17		
PF 4.5, external Ø 4.8 mm, height 10.0 mm	3.03.011	17		
PF 5.0, external Ø 5.3 mm, height 10.0 mm	3.03.012	17		
PF 6.0, external Ø 6.3 mm, height 10.0 mm	3.03.013	17		
Impression coping for open tray technique, reusable, retentive, screw-retained, conical				
PF 4.0, external Ø 5.0 mm, height 16.0 mm	3.04.037	17		
PF 4.5, external Ø 5.5 mm, height 16.0 mm	3.04.038	17		
PF 5.0, external Ø 6.0 mm, height 16.0 mm	3.04.039	17		
PF 6.0, external Ø 7.0 mm, height 16.0 mm	3.04.040	17		
Impression coping for PF 3.0, for open tray technique, reusable, retentive, screw-retained PF 3.0, external 3.3 mm, height 16.0 mm			3.04.028	11
Impression coping for open tray technique, reusable, retentive, screw-retained, cylindrical				
PF 3.5, external Ø 3.8 mm, height 16.0 mm	3.04.020	17		
PF 4.0, external Ø 4.3 mm, height 16.0 mm	3.04.021	17		
PF 4.5, external Ø 4.8 mm, height 16.0 mm	3.04.022	17		
PF 5.0, external Ø 5.3 mm, height 16.0 mm	3.04.023	17		
PF 6.0, external Ø 6.3 mm, height 16.0 mm	3.04.024	17		
Impression coping for bar, Ø 6.0 mm, height 5.0 mm	3.03.101	19,50		
Initial drill, guided, length 28.5 mm	3.04.110	56		
Instrument holder set, for surgical cassette				
consisting of 1 holder, size M	8.03.091	57		
consisting of 2 holders, size S	8.03.090 Q2	57		
Insertion device for implant analog for CAD/CAM				
PF 3.5, length 35.0 mm	3.03.158	12,20,55		
PF 4.0-6.0, length 35.0 mm	3.03.159	20,55		
Insertion device for VARIOmulti analog for CAD/CAM	3.03.157	21,38,55		
L Laboratory cylindrical pin (5 pieces)				
PF 3.5, length 70.0 mm	2.03.450 Q5	11,33,36		
PF 4.0-6.0, length 70.0 mm	2.03.451 Q5	33,36		
Laboratory screw				
PF 3.5, length 25.0 mm	3.03.515	33		
PF 3.5, length 25.0 mm (5 pieces)	3.03.515 Q5	33		
PF 4.0-6.0, length 25.0 mm	3.03.516	33		
PF 4.0-6.0, length 25.0 mm (5 pieces)	3.03.516 Q5	33		
LOCATOR® impression coping (4 pieces)	8505	19,52		
LOCATOR® block-out spacer (20 pieces)	8514	52		
LOCATOR® abutment				
PF 3.5, collar height 0.73 mm	8875	51		
PF 3.5, collar height 2.0 mm	8876	51		
PF 3.5, collar height 3.0 mm	8877	51		
PF 3.5, collar height 4.0 mm	8878	51		
PF 3.5, collar height 5.0 mm, only available in the US	8879	51		
PF 3.5, collar height 6.0 mm, only available in the US	8880	51		
PF 4.0, collar height 1.0 mm	8461	51		
PF 4.0, collar height 2.0 mm	8462	51		
PF 4.0, collar height 3.0 mm	8463	51		
PF 4.0, collar height 4.0 mm	8464	51		
PF 4.0, collar height 5.0 mm	8465	51		
PF 4.0, collar height 6.0 mm	8466	51		
PF 4.5, collar height 1.0 mm	8786	51		
PF 4.5, collar height 2.0 mm	8787	51		
PF 4.5, collar height 3.0 mm	8788	51		
PF 4.5, collar height 4.0 mm	8789	51		
PF 4.5, collar height 5.0 mm	8790	51		
PF 4.5, collar height 6.0 mm	8791	51		
PF 5.0, collar height 1.0 mm	8792	51		
PF 5.0, collar height 2.0 mm	8793	51		

PF 5.0, collar height 3.0 mm	8794	51
PF 5.0, collar height 4.0 mm	8795	51
PF 5.0, collar height 5.0 mm	8796	51
PF 5.0, collar height 6.0 mm	8797	51
PF 6.0, collar height 1.0 mm	8881	51
PF 6.0, collar height 2.0 mm	8882	51
PF 6.0, collar height 3.0 mm	8883	51
PF 6.0, collar height 4.0 mm	8884	51

LOCATOR® abutment and collar for VARIOmulti (2 pieces) collar height 3.0 mm	8909-2	51
---	--------	----

LOCATOR® analog		
Ø 4.0 mm [preferably used with PF 3.5, 4.0 and 4.5] (4 pieces)	8530	21,52
Ø 5.0 mm [preferably used with PF 5.0 and 6.0] (4 pieces)	8516	21,52

LOCATOR® insert for hand piece and for short MONO insert device		
length 23.0 mm	8913	52
length 29.0 mm	8914	52

LOCATOR® male replacement (4 pieces)		
blue, «extra-light retention»	8529	51
pink, «light retention»	8527	51
clear	8524	51

LOCATOR® male replacement, for extended range (4 pieces)		
green	8547	51
orange, «light retention»	8915	51
red «extra-light retention»	8548	51

LOCATOR® core tool	8393	52
LOCATOR® laboratory set (pack contains 2 sets)	8519-2	51

LOCATOR® laboratory set, for extended range (pack contains 2 sets)	8540-2	51
---	--------	----

LOCATOR® parallel posts (4 pieces)	8517	52
LOCATOR® male processing, black (20 pieces)	8515-20	52

LOCATOR® angle measurement guide, height 15.0 mm, width 50.0 mm	9530	52
--	------	----

M Milling abutment

PF 3.5, height 11.0 mm	4.03.420	49
PF 4.0, height 12.0 mm	4.03.428	49
PF 4.5, height 12.0 mm	4.03.421	49
PF 5.0, height 12.0 mm	4.03.422	49
PF 6.0, height 12.0 mm	4.03.423	49

Milling abutment for CAD/CAM Type II, incl. abutment screw		
PF 3.5, length 15.0 mm, Ø 8.0 mm	1.04.401	35
PF 4.0, length 15.0 mm, Ø 11.5 mm	1.04.403	35
PF 4.5, length 15.0 mm, Ø 11.5 mm	1.04.405	35
PF 5.0, length 15.0 mm, Ø 11.5 mm	1.04.407	35
PF 6.0, length 15.0 mm, Ø 11.5 mm	1.04.409	35
MONO torque ratchet, length 110.0 mm	3.03.160	54

MONO insertion device		
short, length 15.4 mm	3.03.162	40,42,55
long, length 25.8 mm	3.03.163	40,42,55

MONO insertion device for retentive anchor		
length 26.0 mm, Ø 8.5 mm	3.03.169	49

MONO guide key, length 94.7 mm	3.03.203	54
---------------------------------------	----------	----

MONO screwdriver (4-lobe)		
extra short, length 14.5 mm, shaft length 5.1 mm	3.03.165	55
short, length 22.2 mm, shaft length 10.3 mm	3.03.166	55
long, length 28.2 mm, shaft length 16.3 mm	3.03.167	55

MONO circlip (2 pieces)	2.03.170 Q2	54
--------------------------------	-------------	----

Mucosa punch, reusable		
PF 3.5, length 27.0 mm	3.03.315	9
PF 4.0, length 27.0 mm	3.03.316	9
PF 4.5, length 27.0 mm	3.03.320	9
PF 5.0, length 27.0 mm	3.03.317	9
PF 6.0, length 27.0 mm	3.03.318	9

O Occlusal screw for bar (4-lobe), length 4.3 mm	4.03.506	50
Occlusal screw (4-lobe), length 3.5 mm	4.03.507	37, 41

P Permanent filter, 1200 sterilization cycles length 95.0 mm, width 215.0 mm	ER802.020	57
---	-----------	----

Positioning handle, length 17.0 mm, Ø 6.0 mm	3.03.522	16,17
---	----------	-------

Positioning handle for angled VARIO and VARIOmulti abutments, length 25.0 mm, Ø 4.0 mm	3.03.521	40,42
---	----------	-------

Prosthetic cassette, incl. screw organizer		
length 190.0 mm, width 140.0 mm, height 58.0 mm	1.03.022	57

Profile drill CONTACT AND ELEMENT, guided		
Profile drill CONTACT MC, Ø 3.5 mm, length 34.0 mm	3.04.171	56
Profile drill CONTACT MC, Ø 4.0 mm, length 34.0 mm	3.04.172	56

Profile drill CONTACT MC, Ø 4.5 mm, length 34.0 mm	3.04.173	56
---	----------	----

Profile drill CONTACT RC, Ø 3.5 mm, length 32.5 mm	3.04.161	56
---	----------	----

Profile drill CONTACT RC Ø 4.0 mm, length 32.5 mm	3.04.162	56
--	----------	----

Profile drill CONTACT RC Ø 4.5 mm, length 32.5 mm	3.04.163	56
--	----------	----

Profile drill ELEMENT MC, Ø 3.5 mm, length 31.5 mm	3.04.151	56
---	----------	----

Profile drill ELEMENT MC, Ø 4.0 mm, length 34.5 mm	3.04.152	56
---	----------	----

Profile drill ELEMENT MC, Ø 4.5 mm, length 37.5 mm	3.04.153	56
---	----------	----

R Retentive anchor

PF 4.0, short, height 1.8 mm	4.03.048	49
------------------------------	----------	----

PF 4.0, long, height 3.0 mm	4.03.049	49
-----------------------------	----------	----

PF 4.5, short, height 1.8 mm	4.03.040	49
------------------------------	----------	----

PF 4.5, long, height 3.0 mm	4.03.041	49
-----------------------------	----------	----

PF 5.0, short, height 1.8 mm	4.03.042	49
------------------------------	----------	----

PF 5.0, long, height 3.0 mm	4.03.043	49
-----------------------------	----------	----

Retentive anchor analog, length 13.0 mm	3.03.033	21,49
--	----------	-------

S Scan abutment PF 3.0

Scan abutment	3.03.774	12
---------------	----------	----

Scan abutment		
PF 3.5	3.03.775	18
PF 4.0	3.03.776	18
PF 4.5	3.03.777	18
PF 5.0	3.03.778	18
PF 6.0	3.03.779	18

Screw for impression copings, reusable (4-lobe)		
PF 3.5, extra short, length 12.5 mm	3.03.572	11,16,17,18
PF 3.5, short, length 16.5 mm	3.03.573	16,17
PF 3.5, long, length 21.5 mm	3.03.574	11,17
PF 3.5, extra long, length 27.5 mm	3.03.580	11,17
PF 4.0-6.0, extra short, length 13.2 mm	3.03.575	16,17,18
PF 4.0-6.0, short, length 17.2 mm	3.03.576	16,17
PF 4.0-6.0, long, length 22.2 mm	3.03.577	17
PF 4.0-6.0, extra long, length 28.2 mm	3.03.581	17

Screw organizer for prosthetic cassette		
length 56.0 mm, width 47.0 mm, height 28.0 mm	8.03.019	57

Screwdriver for hand piece (4-lobe)		
extra short, length 17.0 mm, shaft length 3.5 mm	3.03.500	54
extra long, length 38.0 mm, shaft length 24.5 mm	3.03.503	54
short, length 22.0 mm, shaft length 8.0 mm	3.03.501	54
long, length 28.0 mm, shaft length 14.5 mm	3.03.502	54

Seating instrument for guiding sleeve Ø 4.8 mm	3.04.100	56
---	----------	----

Silicone holder set, for surgical and prosthetic cassettes	1.03.056	57
---	----------	----

Solder pin for bar, length 13.5 mm	3.03.151	50
---	----------	----

Single-use-paper-filter (100 per pack)		
length 118.0 mm, width 235.0 mm	ER802.000N	57

Surgical cassette for guided surgery, for mechanical cleaning	1.04.020	57
--	----------	----

Surgical cassette, for mechanical cleaning		
length 274.8 mm, width 176.0 mm, height 63.6 mm	1.03.030	57

T Thread tap, reusable

endosseous Ø 3.5 mm, length 34.0 mm	3.03.680	9
-------------------------------------	----------	---

endosseous Ø 4.0 mm, length 34.0 mm	3.03.682	9
-------------------------------------	----------	---

endosseous Ø 4.2 mm, length 34.0 mm	3.03.684	9
-------------------------------------	----------	---

endosseous Ø 5.0 mm, length 34.0 mm	3.03.686	9
-------------------------------------	----------	---

endosseous Ø 6.0 mm, length 34.0 mm	3.03.688	9
-------------------------------------	----------	---

Titanium Base bridge for CAD/CAM, incl. abutment screw		
PF 3.5, height 5.2 mm	1.04.760	33
PF 4.0, height 5.2 mm	1.04.761	33
PF 4.5, height 5.2 mm	1.04.762	33
PF 5.0, height 5.2 mm	1.04.763	33
PF 6.0, height 5.2 mm	1.04.764	33

Titanium base with hexagon for CAD/CAM, incl. abutment screw		
PF 3.5, height 5.2 mm	1.04.750	33
PF 4.0, height 5.2 mm	1.04.751	33
PF 4.5, height 5.2 mm	1.04.752	33
PF 5.0, height 5.2 mm	1.04.753	33
PF 6.0, height 5.2 mm	1.04.754	33
Titanium cap for bar, height 4.7 mm	4.03.070	50

U Ultrasonic cleaning-cassette

length 160.0 mm, width 72.0 mm, height 28.0 mm	8.03.059	57
--	----------	----

V VARIO abutment 17° set

Type A, PF 3.5, height 5.6 mm, shoulder height 0.5 mm	1.03.160	41
---	----------	----

Type A, PF 4.0, height 5.6 mm, shoulder height 0.5 mm	1.03.161	41
---	----------	----

Type A, PF 4.5, height 5.6 mm, shoulder height 0.5 mm	1.03.162	41
---	----------	----

Type A, PF 5.0, height 5.6 mm, shoulder height 0.5 mm	1.03.163	41
---	----------	----











Type B, PF 3.5, height 5.6 mm, shoulder height 0.5 mm	1.03.180	41
Type B, PF 4.0, height 5.6 mm, shoulder height 0.5 mm	1.03.181	41
Type B, PF 4.5, height 5.6 mm, shoulder height 0.5 mm	1.03.182	41
Type B, PF 5.0, height 5.6 mm, shoulder height 0.5 mm	1.03.183	41
VARIOeco burn-out plastic cap, for titanium base		
PF 3.5, height 12.0 mm	2.03.790	33
PF 4.0, height 12.0 mm	2.03.791	33
PF 4.5, height 12.0 mm	2.03.792	33
PF 5.0, height 12.0 mm	2.03.793	33
PF 6.0, height 12.0 mm	2.03.794	33
VARIO reamer for screw channel		
PF 3.5, length 44.0 mm	3.03.435	42
PF 4.0-6.0, length 44.0 mm	3.03.436	42
VARIO guide pin for VARIO reamer		
PF 4.0, length 12.5 mm	3.03.425	42
PF 4.5-6.0, length 12.5 mm	3.03.423	42
VARIO guide pin for VARIO/ VARIOmulti reamer		
PF 3.5, length 15.0 mm	3.03.424	40,42
VARIOflex abutment set for bridge		
PF 3.5, height 12.0 mm	1.04.835	36
PF 4.0, height 12.0 mm	1.04.836	36
PF 4.5, height 12.0 mm	1.04.837	36
PF 5.0, height 12.0 mm	1.04.838	36
PF 6.0, height 12.0 mm	1.04.839	36
VARIOflex abutment set for crown		
PF 3.5, height 12.0 mm	1.04.830	36
PF 4.0, height 12.0 mm	1.04.831	36
PF 4.5, height 12.0 mm	1.04.832	36
PF 5.0, height 12.0 mm	1.04.833	36
PF 6.0, height 12.0 mm	1.04.834	36
VARIOflex burn-out plastic cap		
PF 3.5, height 11.5 mm	2.03.840	36
PF 4.0, height 11.5 mm	2.03.841	36
PF 4.5, height 11.5 mm	2.03.842	36
PF 5.0, height 11.5 mm	2.03.843	36
PF 6.0, height 11.5 mm	2.03.844	36
VARIO gold abutment for bridge		
PF 3.5, height 12.7 mm, cone 3.5 mm	2.03.400	41
PF 4.0, height 12.7 mm, cone 3.5 mm	2.03.404	41
PF 4.5, height 12.7 mm, cone 3.5 mm	2.03.401	41
PF 5.0, height 12.7 mm, cone 3.5 mm	2.03.402	41
PF 6.0, height 12.7 mm, cone 3.5 mm	2.03.403	41
VARIO gold abutment for crown		
PF 3.5, height 12.7 mm, cone 3.5 mm	2.03.410	41
PF 4.0, height 12.7 mm, cone 3.5 mm	2.03.414	41
PF 4.5, height 12.7 mm, cone 3.5 mm	2.03.411	41
PF 5.0, height 12.7 mm, cone 3.5 mm	2.03.412	41
PF 6.0, height 12.7 mm, cone 3.5 mm	2.03.413	41
VARIOmulti impression coping, Ø 5.3 mm, height 18.0 mm	3.04.805	19,38
VARIOmulti abutment angled, 17°		
PF 3.5, height 4.3 mm, shoulder height 2.7 mm	4.03.680	37
PF 4.0, height 4.3 mm, shoulder height 2.7 mm	4.03.681	37
PF 4.5, height 4.3 mm, shoulder height 2.7 mm	4.03.682	37
PF 5.0, height 4.3 mm, shoulder height 2.7 mm	4.03.683	37
PF 6.0, height 4.3 mm, shoulder height 2.7 mm	4.03.684	37
VARIOmulti abutment angled, 30°		
PF 3.5, height 4.4 mm, shoulder height 3.3 mm	4.03.685	37
PF 4.0, height 4.4 mm, shoulder height 3.3 mm	4.03.686	37
PF 4.5, height 4.4 mm, shoulder height 3.3 mm	4.03.687	37
PF 5.0, height 4.4 mm, shoulder height 3.3 mm	4.03.688	37
PF 6.0, height 4.4 mm, shoulder height 3.3 mm	4.03.689	37
VARIOmulti abutment, with handle		
PF 3.5, height 3.0 mm, shoulder height 0.8 mm	4.03.600	37
PF 3.5, height 4.2 mm, shoulder height 2.0 mm	4.03.605	37
PF 3.5, height 5.2 mm, shoulder height 3.0 mm	4.03.610	37
PF 4.0, height 3.0 mm, shoulder height 0.8 mm	4.03.601	37
PF 4.0, height 4.2 mm, shoulder height 2.0 mm	4.03.606	37
PF 4.0, height 5.2 mm, shoulder height 3.0 mm	4.03.611	37
PF 4.5, height 3.0 mm, shoulder height 0.8 mm	4.03.602	37
PF 4.5, height 4.2 mm, shoulder height 2.0 mm	4.03.607	37
PF 4.5, height 5.2 mm, shoulder height 3.0 mm	4.03.612	37
PF 5.0, height 3.0 mm, shoulder height 0.8 mm	4.03.603	37
PF 5.0, height 4.2 mm, shoulder height 2.0 mm	4.03.608	37
PF 5.0, height 5.2 mm, shoulder height 3.0 mm	4.03.613	37
PF 6.0, height 3.7 mm, shoulder height 1.5 mm	4.03.604	37
VARIOmulti analog, Ø 4.8 mm, height 21.2 mm	3.03.800	21,38
VARIOmulti analog for CAD/CAM, titanium	3.03.083	21,38

VARIOmulti reamer for screw channel, length 40.0 mm	3.03.437	40
VARIOmulti gold cap, incl. burn-out plastic cylinder, Ø 4.8 mm, height 4.2/13.5 mm	2.03.600	39
VARIOmulti burn-out cap (2 pieces) Ø 4.8 mm, height 13.5 mm	2.03.601 Q2	39
VARIOmulti temporary cap, incl. fabrication screw Ø 5.2 mm, height 15.0 mm	3.03.804	38
VARIOmulti scan abutment, titanium, surface treated Ø 4.5 mm, height 8.0 mm	3.03.780	18,39
VARIOmulti scan abutment, short, titanium, surface treated Ø 5.0 mm, height 5.0 mm	3.03.781	18,39
VARIOmulti protective cap Ø 5.3 mm, height 4.5 mm	4.03.801	38
VARIOmulti titanium base for CAD/CAM, incl. occlusal screw, titan/titanium alloy Ø 4.8 mm, height 4.5 mm	1.04.850	39
VARIOmulti titanium base for CAD/CAM, customizable, incl. occlusal screw, titanium/titanium alloy Ø 4.8 mm, height 9.0 mm	1.04.851	39
VARIO 17° gold screw seat (fits all platform sizes) Ø 2.9 mm, height 2.0/11.3 mm	2.03.610	41
VARIOtemp abutment set for bridges		
PF 3.5, height 12.0 mm	1.04.085	32
PF 4.0, height 12.0 mm	1.04.086	32
PF 4.5, height 12.0 mm	1.04.087	32
PF 5.0, height 12.0 mm	1.04.088	32
PF 6.0, height 12.0 mm	1.04.089	32
VARIOtemp abutment set for crowns		
PF 3.5, height 12.0 mm	1.04.080	32
PF 4.0, height 12.0 mm	1.04.081	32
PF 4.5, height 12.0 mm	1.04.082	32
PF 5.0, height 12.0 mm	1.04.083	32
PF 6.0, height 12.0 mm	1.04.084	32
VARIO/VARIOmulti reamer for base		
PF 3.5-4.0, length 16.0 mm	3.03.420	40,42
VARIO/VARIOmulti reamer for base		
PF 4.5-6.0, length 16.0 mm	3.03.421	42
VARIOunite abutment PF 3.0 for crown	1.04.138	11
VARIOunite burn-out plastic cap PF 3.0,	2.03.848	11
VECTOdrill™ twist drill, single use (4 pieces)		
Pilot drill Ø 2.0 mm, extra short, length 29.0 mm, for implants of length 6.5-14.0 mm	3.03.624 Q4	8
Pilot drill Ø 2.0 mm, short, length 34.0 mm	3.03.610 Q4	8
Pilot drill Ø 2.0 mm, long, length 40.0 mm	3.03.611 Q4	8,10
Drill Ø 2.8 mm, extra short, length 29.0 mm, for implants of length 6.5-14.0 mm	3.03.625 Q4	8
Drill Ø 2.8 mm, short, length 34.0 mm	3.03.612 Q4	8,10
Drill Ø 2.8 mm, long, length 40.0 mm	3.03.613 Q4	8
Drill Ø 3.5 mm, extra short, length 29.0 mm, for implants of length 6.5-14.0 mm	3.03.626 Q4	8
Drill Ø 3.5 mm, short, length 34.0 mm	3.03.614 Q4	8
Drill Ø 3.5 mm, long, length 40.0 mm	3.03.615 Q4	8
Drill Ø 4.3 mm, extra short, length 29.0 mm, for implants of length 6.5-14.0 mm	3.03.627 Q4	8
Drill Ø 4.3 mm, short, length 34.0 mm	3.03.616 Q4	8
Drill Ø 4.3 mm, long, length 40.0 mm	3.03.617 Q4	8
Drill Ø 5.3 mm, extra short, length 29.0 mm, for implants of length 6.5-14.0 mm	3.03.628 Q4	8
Drill Ø 5.3 mm, short, length 34.0 mm	3.03.618 Q4	8
VECTOdrill™ twist drill, reusable		
Pilot drill Ø 2.0 mm, extra short, length 29.0 mm, for implants of length 6.5-14.0 mm	3.03.710	8
Pilot drill Ø 2.0 mm, short, length 34.0 mm	3.03.720	8
Pilot drill Ø 2.0 mm, long, length 40.0 mm	3.03.730	8,10
Drill Ø 2.8 mm, extra short, length 29.0 mm, for implants of length 6.5-14.0 mm	3.03.712	8
Drill Ø 2.8 mm, short, length 34.0 mm	3.03.722	8
Drill Ø 2.8 mm, long, length 40.0 mm	3.03.732	8
Drill Ø 3.5 mm, extra short, length 29.0 mm, for implants of length 6.5-14.0 mm	3.03.714	8
Drill Ø 3.5 mm, short, length 34.0 mm	3.03.724	8
Drill Ø 3.5 mm, long, length 40.0 mm	3.03.734	8
Drill Ø 4.3 mm, extra short, length 29.0 mm, for implants of length 6.5-14.0 mm	3.03.716	8
Drill Ø 4.3 mm, short, length 34.0 mm	3.03.726	8
Drill Ø 4.3 mm, long, length 40.0 mm	3.03.736	8

X	X-ray reference sphere, \varnothing 5.0 mm	3.03.140	7
	X-ray template, for planning with two-dimensional		
	x-ray devices		
	for the CONTACT implant line	Fo_20d185	7
	for the ELEMENT implant line	Fo_20d184	7,10
	X-ray reference sphere, \varnothing 5.0 mm	3.03.140	7
	X-ray template, for planning with two-dimensional		
	x-ray devices		
	for the CONTACT implant line	Fo_20d185	7
	for the ELEMENT implant line	Fo_20d184	7,10
	X-ray reference sphere, \varnothing 5.0 mm	3.03.140	7
	X-ray template, for planning with two-dimensional		
	x-ray devices		
	for the CONTACT implant line	Fo_20d185	7
	for the ELEMENT implant line	Fo_20d184	7,10

Torque values

www.ifu-tm.com/THM61122

Abutment/screw	Torque values in Ncm				
	10	15	20	25	30
Healing cap Gingiva former Gingiva former+ Gingiva former narrow 	PF 3.0				
	PF 3.5				
	PF 4.0				
	PF 4.5				
	PF 5.0				
Abutment screws 		PF 3.0			
		PF 3.5			
				PF 4.0	
				PF 4.5	
				PF 5.0	
Dynamic abutment screw 		PF 3.5			
				PF 4.0	
				PF 4.5	
				PF 5.0	
Abutment screw in combination with ART abutment 		PF 3.5			
			PF 4.0		
			PF 4.5		
			PF 5.0		
VARIOmulti abutment 		PF 3.5			
				PF 4.0	
				PF 4.5	
				PF 5.0	
VARIOmulti protective cap 	PF 3.5				
	PF 4.0				
	PF 4.5				
	PF 5.0				
	PF 6.0				
Occlusal screw (VARIOmulti, VARIO 17°, bar) Occlusal closure screw, CAD/CAM bar 		PF 3.5			
		PF 4.0			
		PF 4.5			
		PF 5.0			
Retentive anchor 				PF 4.0	
				PF 4.5	
				PF 5.0	
ZEST LOCATOR® abutment 			PF 3.5		
					PF 4.0
					PF 4.5
					PF 5.0
ZEST LOCATOR® abutment and collar for VARIOmulti 			PF 4.0		
			PF 4.5		
			PF 5.0		
			PF 6.0		

New abutment screws must always be used for permanent insertion of the supraconstruction in the mouth.

General notes

THOMMEN IMPLANT SYSTEM



Manufacturer: Thommen Medical AG
Neckarsulmstrasse 28
2540 Grenchen, Switzerland
www.thommenmedical.com



Batch code



Use by date



Date of manufacture



Sterilized using irradiation



Simple sterile barrier system



Simple sterile barrier system with protective packaging on the inside



Not more than 20 reprocessing cycles



European representative



Temperature limitation



Do not re-use



Non-sterile



Caution



Article number



Conformity symbol in accordance with Directive No: MDD 93/42/EEC or Regulation (EU) No: 2017/745 MDR (see corresponding conformity declaration)



Consult instructions for use



Do not resterilize



Do not use if package is damaged



Atmospheric pressure limitation



Manufacturer



Country of manufacture



Importer



Dealers



Keep away from sunlight



May only be sold to and prescribed by physicians (USA)



Medical device



Single product code

COLORED WARNING STICKER

Application was changed – follow the directions in the corresponding instructions for use.

NEW HANDLING

New design – the application has not been changed.

NEW DESIGN

PRODUCT INFORMATION The information in this document describes the application of the Thommen Medical implant system. This information is available in electronic form online at: www.ifu-tm.com. The responsible country representative or distributor for Thommen Medical AG is available to provide technical advice.

COLOR CODE Each implant platform diameter has a color code, which can be found on all implant packagings, on the impression items and on most diameter-specific instruments.

TRACEABILITY

In order to ensure the traceability of the implantable products as well as the manufacturer, product type and product dimensions also for a later prosthetic re-restoration, each product package comes with three patient labels. These labels should be used in the practice for documentation and for the implant passport.

Brown	=	PF 3.0
Yellow	=	PF 3.5
Green	=	PF 4.0
Blue	=	PF 4.5
Grey	=	PF 5.0
Purple	=	PF 6.0

AVAILABILITY Not all of the Thommen Medical products mentioned in these instructions for use are available in all countries. The responsible country representative or distributor for Thommen Medical AG can provide information about availability of Thommen Medical products for the country in question.

GENERAL RESTRICTIONS OF USE Restorations with cantilevers to individual implants are not recommended. Individual restorations with angled abutments should not be used in regions with high mechanical stress. For implants with a small diameter (PF 3.0 and 3.5), the prosthetic restoration should be constructed in such a way that a large bending moment does not occur.

CONTRAINDICATION The Thommen Medical products may not be used on patients who are known to have allergies to the corresponding materials.

POSSIBLE COMPLICATIONS A stressed loading of the implant or abutment over and above its functional capacity can lead to excessive bone loss or fracture of the implant or restoration. The clinician must supervise the occlusion and functional loading of the prosthetic supraconstruction very carefully.

SIDE EFFECTS The patient should be informed about the possible side effects, interactions, precautionary measures and complications associated with Thommen Medical products. Potential complications can occur immediately after insertion of dental implants: Temporary symptoms: swelling, difficulties with speaking, gum inflammations, pain.

Longer lasting symptoms: chronic pain connected with the dental implant, localized or systemic infections, dysesthesia, loss of alveolar ridge (upper and lower jaw), oroantral or oronasal fistulas, irreversible damage to neighboring teeth, esthetic problems, nerve damage, hyperplasia. Other possible side effect: implant loss.

WARNINGS All Thommen Medical products that come into effect inside the oral cavity must be protected against aspiration. Thommen Medical products have not been tested for safety and compatibility in an MR environment. Thommen Medical products have not been tested for heating or migration in the MR environment. The safety of Thommen Medical products in the MR environment is unknown. Magnetic resonance tomographic examinations of patients, who have been treated with Thommen Medical products, may result in patient injuries.

RESPONSIBILITY/LIABILITY As a part of an overall scheme, Thommen Medical products may be used only with the related original components and instruments in accordance with the instructions for use provided by Thommen Medical. The use of non-system parts may compromise the performance of Thommen Medical products and lead to failures. Users must have appropriate knowledge and information about the handling of Thommen Medical products in order to use the products safely and correctly. The user is obliged to use the Thommen Medical products according to the instructions for use and to check whether the product is suitable for the individual patient situation. The use of Thommen Medical products is the responsibility of the user, as such, beyond the control of Thommen Medical AG. We refuse to accept any responsibility or liability for any damage due to incorrect utilization of the product. Products labeled "Do not re-use" may not be refurbished and/or reused. The refurbishment and/or reuse of these products can affect their function (e.g. fitting and/or cutting properties) as well as their safe use (e.g. risk of infection, disease transmission, fading of the laser or color marks, corrosion). De-

tailed information about the possible consequences, which may result from incorrect use, is available from the responsible country representative or distributor of Thommen Medical AG. All serious incidents which have occurred in connection with the product must be reported to the manufacturer and to the local competent authority in the country where the user is resident.

GUARANTEE The comprehensive guarantees can be found in the country-specific guarantee leaflets.

TRANSPORT AND STORAGE Please note the specifications on the labels and instructions for use regarding transportation, storage and handling. If the packaging is damaged, the products must not be used; a visual inspection is necessary. Under no circumstances may Thommen Medical products be used beyond the expiry date, as proper functioning or sterility of sterile packaged products cannot be guaranteed by the manufacturer.

APPLICATION The following descriptions are not intended as comprehensive for the immediate use of the Thommen Medical Implant System. Training by a specialist experienced in the use of this system is recommended

GUARANTEE OF STERILITY In general, products of the Thommen Implant System supplied in sterile packaging must not be re-sterilized. Sterile-packed products, whose packaging is damaged, must not be used under any circumstances. Sterile-supplied products, which have not been used for the surgical operation, whose packaging has been opened are considered as having been used and must not be used thereafter. In the event of re-sterilization, proper function and the sterility cannot be guaranteed by the manufacturer. The products intended for single use must never be reprocessed, sterilized or reused and must be disposed of safely and properly after use in compliance with all applicable legal and regulatory requirements. Reusable products must be reprocessed according to the instructions for use and, if used on patients, sterilized. They must be checked for their integrity before each use. Any damage (for example, scratches, cracks, nicks, dents), as well as bent parts, means that they must not be used any longer. The number of reprocessing cycles is limited and must be monitored. If the number of cycles is exceeded, proper function and sterility of the product are not guaranteed by the manufacturer anymore.

DISPOSAL In the case of cutting products, there is always a risk of injury, therefore the products must be disposed of safely and properly after use, observing all applicable legal and regulatory requirements. For products and their accessories, which have been used on a patient, there is a risk of an infection. Our products are designed and produced so that they can be disposed of safely and correctly after use in compliance with all valid legal and regulatory requirements.

COPYRIGHT®/REGISTERED® SPI®, INICELL® and APLIQUIQ® are registered trademarks of Thommen Medical AG. Publication or reproduction is permitted only with the written consent of Thommen Medical AG. LOCATOR® is a registered trademark of Zest Anchors Inc., CA, USA. Dynamic Tibase® is a registered trademark of Talladium España S.L., Lleida, Spain.

VALIDITY Thommen Medical AG. All previous versions lose their validity with the publication of this instruction for use.



HEADQUARTERS

Thommen Medical AG
Neckarsulmstrasse 28
2540 Grenchen | Switzerland
Tel. +41 61 965 90 20
Fax +41 61 965 90 21
info@thommenmedical.com



SUBSIDIARIES/NATIONAL DISTRIBUTORS

AUSTRIA

Thommen Medical Austria GmbH
Mühlgasse 3
2322 Zwölfaxing | Austria
Tel. +43 660 2011953
info@thommenmedical.at

BENELUX

Thommen Medical Benelux B.V.
Dierenriem 1
3738 TP Maartensdijk | Netherlands
Tel. +31 30 68 68 468
Info.benelux@thommenmedical.nl

CHINA

Shanghai Yujing Trading Co., Ltd.
Room 1112 | Block A | SOHO Zhongshan Plaza
No. 1055 West Zhongshan Rd | Changning District
200051 Shanghai | P.R. China
Tel. +86 21 80121250
Fax +86 21 62175264
sy@shanghaiyujing.com

CZECH REPUBLIC

C. Witt Dental spol. s r.o.
Cihlářská 643/19
602 00 Brno
Tel. +420 739 043 449
helena.novak@cwittdental.cz

FINLAND

Vector Laboratories Oy
Engelinaukio 8 B
00150 Helsinki | Finland
Tel. +358 400 940 700
labs@vektor.fi

FRANCE

Thommen Medical France
Le PARK, Bâtiment B, 1 Rue Charles Cordier
77164 Ferrières-en-Brie | France
Tel. +33 1 83 64 06 35
infos@thommenmedical.fr
commande@thommenmedical.fr



GERMANY

Thommen Medical Deutschland GmbH
Am Rathaus 2
79576 Weil am Rhein | Germany
Tel. +49 7621 422 58 30
Fax +49 7621 422 58 41
info@thommenmedical.de

HONG KONG

Shengyuan (Hong Kong) Int. Trade Co. Ltd.
Level 13, 68 Yee Wo Street
Causeway Bay | Hong Kong
Tel. +852 530 876 41

HUNGARY

Mori-Dent Kft.
Huszt utca 9 | 1147 Budapest
Hungary
Tel. +361 220 5443
morident@morident.hu
www.morident.hu

ITALY

Dental Trey S.r.l.
Via Partisani, 3
47016 Fiumana | Predappio (FC) | Italy
Tel. +39 0543 929111
Fax +39 0543 940659
implantologia@dental Trey.it
www.dental Trey.it

JAPAN

J. Morita Corporation
3-33-18, Tarumi-cho
Suita | Osaka 564-8650 | Japan
Tel. +81 6 6384 6921
Fax +81 6 6384 6746
www.morita.com

JORDAN

Alzynoor for Medical Supplies
Complex No. 243
Barakat Center office 406, JO-Amman 11953 Jordan
Tel. +962 655 39020
alzynoor.medical.jo@gmail.com

KUWAIT

Logident
Yasmin Complex, 1st floor, Office B1
Ibn Khalidun, St Hawally | Kuwait
Tel. +965 5113 8438
omar.alameddin@logidentco.com

LITHUANIA/LATVIA

LT projects, UAB
Europos pr. 121 | Kaunas
LT-46339 Lithuania
Tel. +370 65 771550
info@fordentist.lt
www.fordentist.lt

NORWAY

Novus Dental AS
Måkeveien 6
1679 Kråkerøy. | Norway
post@novusdental.no
www.novusdental.no

OMAN

Al Inshirah Street, Madinat Sultan Qaboos
Building No.185, Way No.1947
P.O. Box 1181, P.C. 112.
Ruwi, Muscat,
Sultanate Of Oman
Tel. +968 24602771
sam@almadinagroup.net

POLAND

C.WITT DENTAL Sp. z o. o.
Ul. Granitowa 10
87-100 Toruń | NIP 951-15-08-371 | Poland
Tel. +48 56 623 61 23
biuro@cwittdental.pl
www.cwittdental.pl

QATAR

Orient gate company
Al - Nasr, Area 39, Street 840, Building No: 53
P.O. Box 45393 | Doha Qatar
Mobile +974 50389808
lyaseen@orientgateqa.com

REPUBLIC OF CROATIA

Futura Dental d.o.o.
Ulica grada Vukovara 271 | Chromosov toranj
10 000 Zagreb | Republic of Croatia
Tel. +385 91 6814 860
info@futura-dental.hr
www.futura-dental.hr

RUSSIAN FEDERATION

Geosoft Surgery LLC.
Vasnetsova Lane, House 7, Office 206
129090 Moscow | Russian Federation
Tel. +7 495 663 22 11
thommenmedical@geosoft.ru
www.geosoft.ru

SAUDI ARABIA

INNOVATION MEDICAL COMPANY
7324 King Abdulaziz Road
Ar-Rabi District
13315 Riyadh | Kingdom of Saudi Arabia
Tel. +966 50 926 5010
contact@innovation-medical.com

SINGAPORE

FONDACO Pte Ltd
7 Kaki Bukit Road 1, #03-06
Eunos Techno Link
Singapore 415937 | Singapore
Tel. +65 6392 2806
Fax +65 6392 1296
fondaco@fondacosg.com

SOUTH KOREA

KMbio
02 Ho, 129, Dongseo-daero
Seobuk-gu, Cheonan-si
Chungcheongnam-do
Republic of Korea
Tel. +82 070 3141 2875
kmbio149@naver.com

SPAIN/PORTUGAL

Thommen Medical Ibérica
C/Los quintos n 1
03350 Cox (Alicante) | Spain
Tel. +34 96 536 10 20
Mobile +34 606 99 78 34
info@thommeniberica.com

SWEDEN

Erik Söderberg Group AB
Vingårdsgatan 7
11758 Stockholm | Sweden
Tel. +46 70 567 00 67
erik@thommenmedical.se
www.thommenmedical.se

SWITZERLAND

Thommen Medical AG
Neckarsulmstrasse 28
2540 Grenchen | Switzerland
Tel. +41 32 644 30 20
Fax +41 32 644 30 25
info@thommenmedical.ch

TAIWAN

En-Jye International Co., Ltd.
No. 18, Lane 177, Sec 3, Chengde Rd.
Taipei, 103 Taiwan | Taiwan
Tel. +886 2 2585 1669
Fax +886 2 2585 0892
enjye168@gmail.com

TURKEY

Bioport Biyolojik Maddeler A. .S.
Büyükdere cd. Subay evleri 9. Blok D1 Esentepe
Şişli 34394 Istanbul | Turkey
Tel. +90 212 2727577
Fax +90 212 2727628
info@bioport.com.tr
www.bioport.com.tr

UKRAINE

BIG TIME GROUP LTD
Kyivska 5/1A | 46016 Ternopil
Ukraine
Tel. +380 67 54 60 147
btgukraine@gmail.com
bigtimegroup.com.ua

USA/CANADA

Thommen Medical USA L.L.C.
1375 Euclid Avenue | Suite 450
Cleveland OH 44115 | USA
Tel. +1 866 319 9800 (toll free)
Fax +1 216 583 9801
info@thommenmedical.us
orders@thommenmedical.us